

GB Fitting Instructions for Basic Carrier

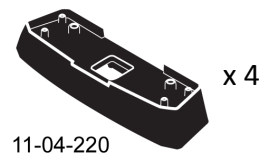

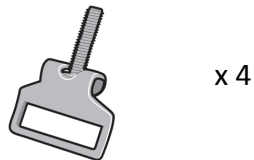

MAX kgs (lbs)

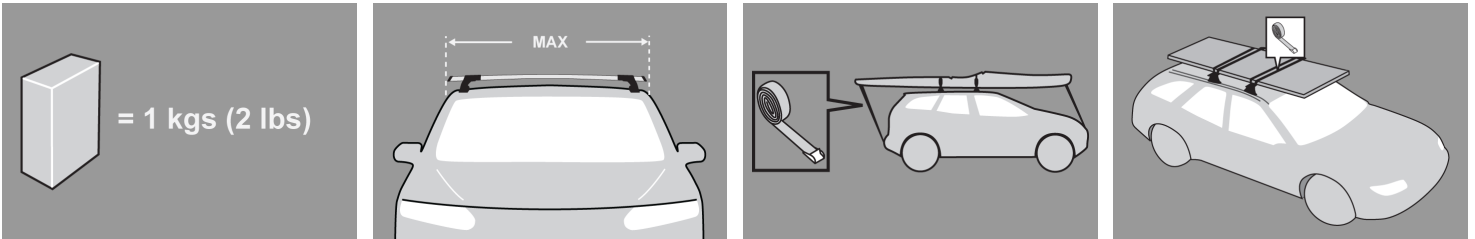
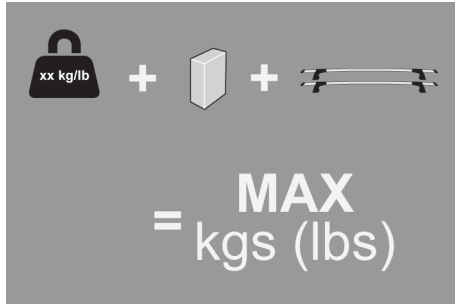

W/P

WHD

Mitsubishi

Airtrek , 5dr SUV 01- 05	EU	50 kgs (110 lbs)	50 kgs (110 lbs)
Airtrek , 5dr SUV 01-Jan 06	NZ	50 kgs (110 lbs)	50 kgs (110 lbs)
Cedia , 4dr Sedan 03- 07	NZ	50 kgs (110 lbs)	50 kgs (110 lbs)
Cedia , 4dr Sedan 03- 07	EU	50 kgs (110 lbs)	50 kgs (110 lbs)
Cedia , 4dr Sedan 03- 07	AU	50 kgs (110 lbs)	50 kgs (110 lbs)
Cedia , 4dr Sedan Feb 01-Jul 03	NZ	50 kgs (110 lbs)	50 kgs (110 lbs)
Chariot Grandis , 5dr MPV 98- 03	EU	50 kgs (110 lbs)	50 kgs (110 lbs)
Colt , 5dr Hatch 03-+	EU	50 kgs (110 lbs)	50 kgs (110 lbs)
Colt , 5dr Hatch Aug 04-+	AU	50 kgs (110 lbs)	50 kgs (110 lbs)
Colt , 5dr Hatch Dec 03-+	NZ	50 kgs (110 lbs)	50 kgs (110 lbs)
Colt Plus, 5dr Wagon Aug 04- 12	NZ	50 kgs (110 lbs)	50 kgs (110 lbs)
Delica D5, 5dr SUV Mar 07-+	NZ	50 kgs (110 lbs)	50 kgs (110 lbs)
Grandis , 5dr MPV 03-+	EU	50 kgs (110 lbs)	50 kgs (110 lbs)
Grandis , 5dr MPV 98-Dec 03	NZ	50 kgs (110 lbs)	50 kgs (110 lbs)
Grandis , 5dr MPV Sep 04-+	NZ	50 kgs (110 lbs)	50 kgs (110 lbs)
Grandis , 5dr MPV Sep 04-+	AU	50 kgs (110 lbs)	50 kgs (110 lbs)
Lancer , 4dr Sedan 00- 03	ZA	50 kgs (110 lbs)	50 kgs (110 lbs)
Lancer , 4dr Sedan 00- 03	EU	50 kgs (110 lbs)	50 kgs (110 lbs)
Lancer , 4dr Sedan 02- 07	US	50 kgs (110 lbs)	50 kgs (110 lbs)
Lancer , 4dr Sedan 03- 06	ZA	50 kgs (110 lbs)	50 kgs (110 lbs)
Lancer , 4dr Sedan 03- 07	EU	50 kgs (110 lbs)	50 kgs (110 lbs)
Lancer , 4dr Sedan Aug 03-Aug 07	NZ	50 kgs (110 lbs)	50 kgs (110 lbs)
Lancer , 4dr Sedan Feb 01-Jul 03	NZ	50 kgs (110 lbs)	50 kgs (110 lbs)
Lancer , 5dr Estate 00- 03	EU	50 kgs (110 lbs)	50 kgs (110 lbs)
Lancer , 5dr Wagon Aug 03-Aug 07	NZ	50 kgs (110 lbs)	50 kgs (110 lbs)
Lancer , 5dr Wagon Feb 01-Jul 03	NZ	50 kgs (110 lbs)	50 kgs (110 lbs)
Lancer CG, 4dr Sedan Jun 02-Jul 03	AU	50 kgs (110 lbs)	50 kgs (110 lbs)
Lancer CH/CS, 4dr Sedan Aug 03-Aug 07	AU	50 kgs (110 lbs)	50 kgs (110 lbs)
Lancer CH/CS, 5dr Wagon Aug 03-Aug 07	AU	50 kgs (110 lbs)	50 kgs (110 lbs)
Legnum , 5dr Wagon 96- 03	NZ	50 kgs (110 lbs)	50 kgs (110 lbs)
Montero , 3dr SUV 99- 06	EU	50 kgs (110 lbs)	50 kgs (110 lbs)
Montero , 5dr SUV 99- 06	EU	75 kgs (165 lbs)	75 kgs (165 lbs)
Nimbus , 5dr MPV Nov 98-Jun 04	NZ	50 kgs (110 lbs)	50 kgs (110 lbs)
Nimbus UG, 5dr MPV Nov 98-Jun 04	AU	50 kgs (110 lbs)	50 kgs (110 lbs)
Outlander , 5dr SUV 03- 06	EU	50 kgs (110 lbs)	50 kgs (110 lbs)
Outlander , 5dr SUV Feb 03-Jan 06	AU	50 kgs (110 lbs)	50 kgs (110 lbs)
Pajero , 5dr SUV 00- 07	EU	75 kgs (165 lbs)	75 kgs (165 lbs)
Pajero IO, 3dr SUV 99- 03	ZA	75 kgs (165 lbs)	75 kgs (165 lbs)
Pajero io, 3dr SUV Jul 97-Jul 03	NZ	75 kgs (165 lbs)	75 kgs (165 lbs)
Pajero io, 3dr SUV Mar 99-Jul 03	AU	75 kgs (165 lbs)	75 kgs (165 lbs)
Pajero IO, 5dr SUV 99- 03	ZA	75 kgs (165 lbs)	75 kgs (165 lbs)
Pajero io, 5dr SUV Mar 99-Jul 03	AU	75 kgs (165 lbs)	75 kgs (165 lbs)
Pajero LWB, 5dr SUV 99- 06	ZA	75 kgs (165 lbs)	75 kgs (165 lbs)
Pajero LWB, 5dr SUV Mar 07-+	NZ	75 kgs (165 lbs)	75 kgs (165 lbs)
Pajero LWB, 5dr SUV May 00-Oct 06	NZ	75 kgs (165 lbs)	75 kgs (165 lbs)
Pajero NM/NP, 5dr SUV May 00-Feb 07	AU	75 kgs (165 lbs)	75 kgs (165 lbs)

Pajero NS, 5dr SUV Mar 07-+	AU	75 kgs (165 lbs)	75 kgs (165 lbs)
Pajero SWB, 3dr SUV Jun 00-Feb 07	AU	50 kgs (110 lbs)	50 kgs (110 lbs)
Pajero SWB, 3dr SUV Jun 00-Oct 06	NZ	50 kgs (110 lbs)	50 kgs (110 lbs)
Pajero SWB, 3dr SUV Mar 07-+	AU	50 kgs (110 lbs)	50 kgs (110 lbs)
Pajero SWB, 3dr SUV Mar 07-+	NZ	50 kgs (110 lbs)	50 kgs (110 lbs)
Pinin , 5dr SUV 98-+	EU	75 kgs (165 lbs)	75 kgs (165 lbs)

Toyota

Granvia , 4dr MPV 96-+	EU	75 kgs (165 lbs)	75 kgs (165 lbs)
Granvia , 4dr MPV 96-+	AU	75 kgs (165 lbs)	75 kgs (165 lbs)
Granvia , 4dr MPV 96-+	NZ	75 kgs (165 lbs)	75 kgs (165 lbs)
Regius , 4dr MPV 97- 02	NZ	75 kgs (165 lbs)	75 kgs (165 lbs)

First Time Installation



- Remove parts from inside the package and check. Contact your dealer if any parts are missing or damaged.

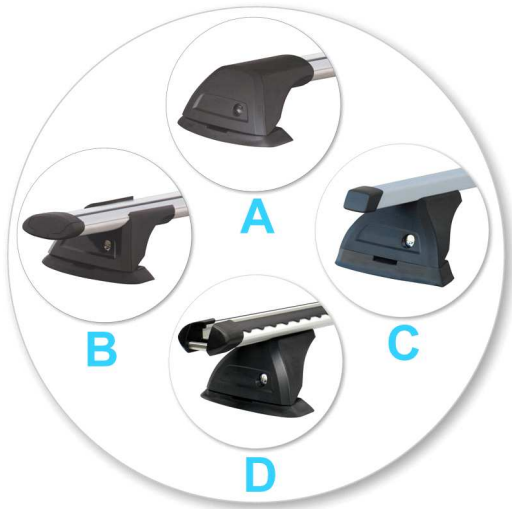

- This kit fits type A, B, C and D.
- These instructions show type A crossbar fitted. They also apply to type B, C and D.



- Use keys to remove covers.



- Use hex screwdriver to reverse adjusting screw 10 turns.



- Press adjusting screw and pull crossbar legs out. Refer to the crossbar instructions for crossbar adjustment.
- Ensure each end of the crossbar is adjusted equally.

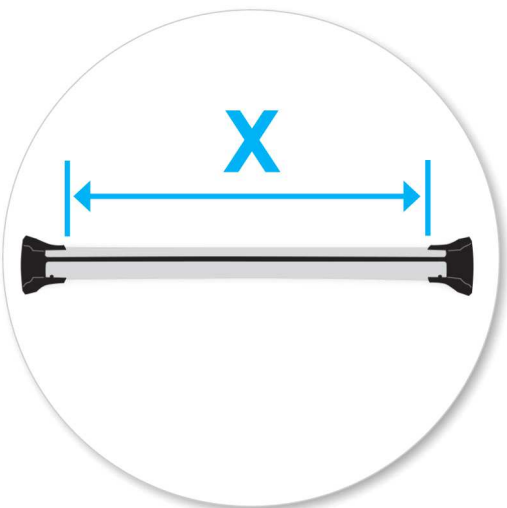

- Adjust crossbar in or out to suit vehicle. Refer to the crossbar instructions for crossbar adjustment.
- Ensure that the crossbar is adjusted evenly at both ends.
- Please check the rear of this manual for information relating specifically to your vehicle.



- Tighten adjusting screw to 5 Nm (3.7 ft lb).

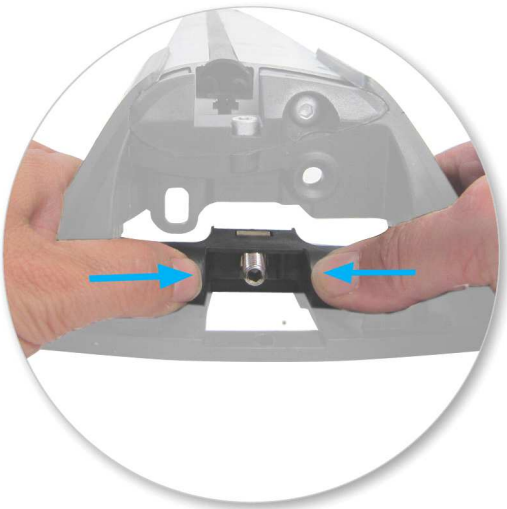

- Remove plastic clamp block by gripping bar leg with fingers and push firmly with thumbs until clamp block drops out behind leg.



- Select plastic internal block (from fitting kit) and insert into foot.



- Fit rubber pads (supplied with fitting kit) to foot. Pad may vary in shape to that shown.



- Make sure the pad fits into the holes underneath the foot.
- Repeat for all legs.

Fitment



- Locate plastic ditch mouldings on roof.
- Run your finger along the inboard edge of the moulding and locate fixed points.



- Pull ditch moulding back towards you.
- Hook clamps into the fixed points on the vehicle.



- Ensure internal clamp sits upright.

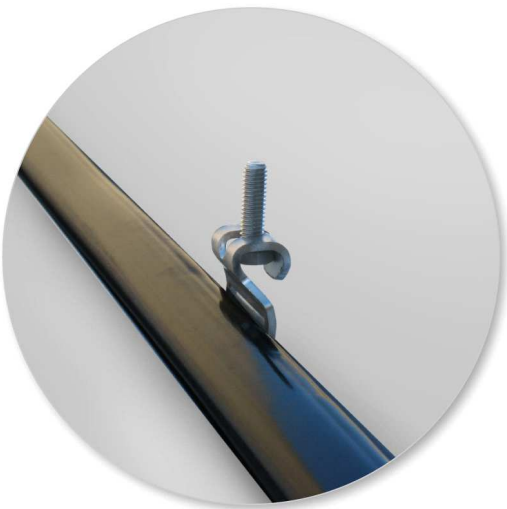

- Repeat for all four positions.



- Place washer over clamp thread as shown.
- Ensure that tab is inserted into clamp block.

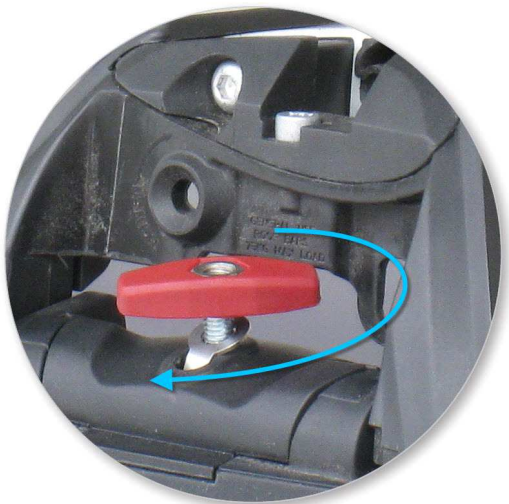

- Tighten the red plastic knob. The side with the nut showing should be facing up.



- Ensure the red plastic knob is in the position shown when fully tightened.
- Repeat for all legs.



- Check crossbar is securely attached to the vehicle.
- Use keys to fit and lock covers

CAUTION: Recheck all fasteners immediately after a load is applied to the crossbars. Regularly check screws are tight.

Maintenance

- Clean the car roof and surfaces of the product that will be in contact with the car roof.
- Follow the fitting instructions for fitting the product to your vehicle. Make sure all steps are carried out in order.
- Set crossbars a minimum distance of 700mm (27 1/2") apart where no other distance is specified in the fitting instructions. This is especially important when carrying long loads.
- Check unit is securely attached whenever you refit it to the vehicle. If the unit feels loose, refer to the fitting instructions and readjust.
- Some glass/panoramic roofs and radio antennae may not be able to be used when the product is fitted.
- Do not modify this product.
- Refer to the maximum permitted load capacity specified in the fitting instructions. Do not exceed the vehicle manufacturers roof load rating if it is lower than the maximum load capacity specified in the fitting instructions.
- Loads should not overhang the sides of the product and be evenly distributed with the lowest possible centre of gravity.
- Long loads should be secured with non-elastic straps to the front and rear of the vehicle.
- Objects with pointed ends (e.g. ski poles) should be carried with the pointed ends to the rear of the vehicle.
- Remove all loose or removable objects from the load prior to loading.
- Make sure all loads are securely fastened with non-elastic straps. Check regularly during longer journeys.

- A loaded roof rack system can alter the performance of your vehicle. Be especially aware of the effects of side winds, changing of direction, and braking performance. Avoid rapid acceleration and deceleration. Drive carefully.
- Note that the total height of the vehicle increases when upright loads are carried.
- Products should be locked during transport if they have locks fitted.
- Check and replace worn out or defective parts.
- Keep the product clean and maintained.
- Never drive into a car wash with the roof rack system fitted.
- Lubricate locks and adjusting screws at regular intervals.
- Remove the products from the vehicle when not in use. Make sure all loose parts are stored safely.

-
- Yakima Australia Pty Ltd
17 Hinkler Court
Brendale QLD 4500
AUSTRALIA

www.whispbar.com
www.whispbar.com.au
www.whispbar.co.nz
www.whispbar.co.uk
www.whispbar.co.za
www.whispbar.eu
www.whispbar.ca

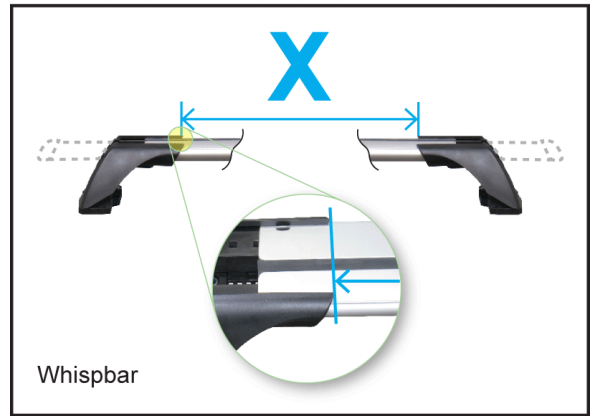
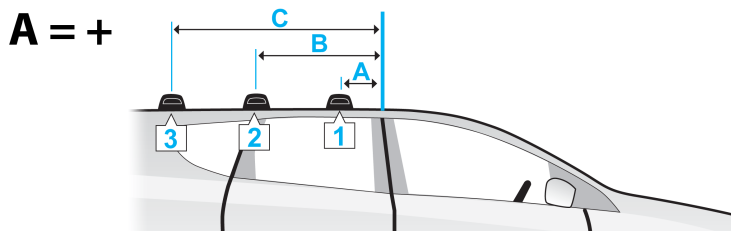
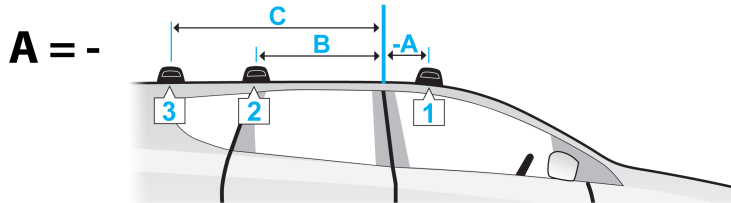

X

	A	B	C	X		
				1	2	3
Mitsubishi Airtrek , 5dr SUV 01- 05 (EU)	200mm 7 7/8"	1000mm 39 3/8"	-	-	-	-
Mitsubishi Airtrek , 5dr SUV 01-Jan 06 (NZ)	200mm 7 7/8"	1000mm 39 3/8"	-	-	-	-
Mitsubishi Cedia , 4dr Sedan 03- 07 (AU)	-270mm -10 5/8"	460mm 18 1/8"	-	816mm 32 1/8"	774mm 30 1/2"	-
Mitsubishi Cedia , 4dr Sedan 03- 07 (EU)	-270mm -10 5/8"	460mm 18 1/8"	-	816mm 32 1/8"	774mm 30 1/2"	-
Mitsubishi Cedia , 4dr Sedan 03- 07 (NZ)	-270mm -10 5/8"	460mm 18 1/8"	-	816mm 32 1/8"	774mm 30 1/2"	-
Mitsubishi Cedia , 4dr Sedan Feb 01-Jul 03 (NZ)	-270mm -10 5/8"	460mm 18 1/8"	-	816mm 32 1/8"	774mm 30 1/2"	-
Mitsubishi Chariot Grandis , 5dr MPV 98- 03 (EU)	-300mm -11 13/16ths"	550mm 21 5/8"	1350mm 53 1/8"	830mm 32 11/16ths"	794mm 31 1/4"	-
Mitsubishi Colt , 5dr Hatch 03-+ (EU)	-100mm -3 15/16ths"	660mm 26 "	-	803mm 31 5/8"	760mm 29 15/16ths"	-
Mitsubishi Colt , 5dr Hatch Aug 04-+ (AU)	-100mm -3 15/16ths"	660mm 26 "	-	803mm 31 5/8"	760mm 29 15/16ths"	-
Mitsubishi Colt , 5dr Hatch Dec 03-+ (NZ)	-100mm -3 15/16ths"	660mm 26 "	-	803mm 31 5/8"	760mm 29 15/16ths"	-
Mitsubishi Colt Plus, 5dr Wagon Aug 04- 12 (NZ)	-100mm -3 15/16ths"	660mm 26 "	-	812mm 31 15/16ths"	766mm 30 3/16ths"	-
Mitsubishi Delica D5, 5dr SUV Mar 07-+ (NZ)	100mm 3 15/16ths"	800mm 31 1/2"	1500mm 59 1/16ths"	1034mm 40 11/16ths"	1007mm 39 5/8"	978mm 38 1/2"
Mitsubishi Grandis , 5dr MPV 03-+ (EU)	190mm 7 1/2"	970mm 38 3/16ths"	-	846mm 33 5/16ths"	824mm 32 7/16ths"	-
Mitsubishi Grandis , 5dr MPV 98-Dec 03 (NZ)	-300mm -11 13/16ths"	550mm 21 5/8"	1350mm 53 1/8"	830mm 32 11/16ths"	794mm 31 1/4"	-
Mitsubishi Grandis , 5dr MPV Sep 04-+ (AU)	190mm 7 1/2"	970mm 38 3/16ths"	-	846mm 33 5/16ths"	824mm 32 7/16ths"	-
Mitsubishi Grandis , 5dr MPV Sep 04-+ (NZ)	190mm 7 1/2"	970mm 38 3/16ths"	-	846mm 33 5/16ths"	824mm 32 7/16ths"	-
Mitsubishi Lancer , 4dr Sedan 00- 03 (EU)	-270mm -10 5/8"	460mm 18 1/8"	-	816mm 32 1/8"	774mm 30 1/2"	-

Mitsubishi Lancer , 4dr Sedan 00- 03 (ZA)	-270mm -10 5/8"	460mm 18 1/8"	- -	816mm 32 1/8"	774mm 30 1/2"	- -
Mitsubishi Lancer , 4dr Sedan 02- 07 (US)	-270mm -10 5/8"	460mm 18 1/8"	- -	816mm 32 1/8"	774mm 30 1/2"	- -
Mitsubishi Lancer , 4dr Sedan 03- 06 (ZA)	-270mm -10 5/8"	460mm 18 1/8"	- -	816mm 32 1/8"	774mm 30 1/2"	- -
Mitsubishi Lancer , 4dr Sedan 03- 07 (EU)	-270mm -10 5/8"	460mm 18 1/8"	- -	816mm 32 1/8"	774mm 30 1/2"	- -
Mitsubishi Lancer , 4dr Sedan Aug 03-Aug 07 (NZ)	-270mm -10 5/8"	460mm 18 1/8"	- -	816mm 32 1/8"	774mm 30 1/2"	- -
Mitsubishi Lancer , 4dr Sedan Feb 01-Jul 03 (NZ)	-270mm -10 5/8"	460mm 18 1/8"	- -	816mm 32 1/8"	774mm 30 1/2"	- -
Mitsubishi Lancer , 5dr Estate 00- 03 (EU)	-135mm -5 5/16ths"	615mm 24 3/16ths"	1230mm 48 7/16ths"	805mm 31 11/16ths"	775mm 30 1/2"	760mm 29 15/16ths"
Mitsubishi Lancer , 5dr Estate 00- 03 (EU)	-135mm -5 5/16ths"	615mm 24 3/16ths"	1230mm 48 7/16ths"	810mm 31 7/8"	775mm 30 1/2"	760mm 29 15/16ths"
Mitsubishi Lancer , 5dr Wagon Aug 03-Aug 07 (NZ)	-150mm -5 7/8"	600mm 23 5/8"	1220mm 48 1/16ths"	810mm 31 7/8"	780mm 30 11/16ths"	760mm 29 15/16ths"
Mitsubishi Lancer , 5dr Wagon Feb 01-Jul 03 (NZ)	-135mm -5 5/16ths"	615mm 24 3/16ths"	1230mm 48 7/16ths"	810mm 31 7/8"	775mm 30 1/2"	760mm 29 15/16ths"
Mitsubishi Lancer , 5dr Wagon Feb 01-Jul 03 (NZ)	-135mm -5 5/16ths"	615mm 24 3/16ths"	1230mm 48 7/16ths"	805mm 31 11/16ths"	775mm 30 1/2"	760mm 29 15/16ths"
Mitsubishi Lancer CG, 4dr Sedan Jun 02-Jul 03 (AU)	-270mm -10 5/8"	460mm 18 1/8"	- -	816mm 32 1/8"	774mm 30 1/2"	- -
Mitsubishi Lancer CH/CS, 4dr Sedan Aug 03-Aug 07 (AU)	-270mm -10 5/8"	460mm 18 1/8"	- -	816mm 32 1/8"	774mm 30 1/2"	- -
Mitsubishi Lancer CH/CS, 5dr Wagon Aug 03-Aug 07 (AU)	-150mm -5 7/8"	600mm 23 5/8"	1220mm 48 1/16ths"	810mm 31 7/8"	780mm 30 11/16ths"	760mm 29 15/16ths"
Mitsubishi Legnum , 5dr Wagon 96- 03 (NZ)	150mm 5 7/8"	800mm 31 1/2"	- -	755mm 29 3/4"	720mm 28 3/8"	- -
Mitsubishi Montero , 3dr SUV 99- 06 (EU)	-100mm -3 15/16ths"	670mm 26 3/8"	- -	900mm 35 7/16ths"	894mm 35 3/16ths"	- -
Mitsubishi Montero , 5dr SUV 99- 06 (EU)	-50mm -1 15/16ths"	700mm 27 9/16ths"	1450mm 57 1/16ths"	900mm 35 7/16ths"	900mm 35 7/16ths"	900mm 35 7/16ths"
Mitsubishi Nimbus , 5dr MPV Nov 98-Jun 04 (NZ)	-300mm -11 13/16ths"	550mm 21 5/8"	1350mm 53 1/8"	830mm 32 11/16ths"	794mm 31 1/4"	- -
Mitsubishi Nimbus UG, 5dr MPV Nov 98-Jun 04 (AU)	-300mm -11 13/16ths"	550mm 21 5/8"	1350mm 53 1/8"	830mm 32 11/16ths"	794mm 31 1/4"	- -
Mitsubishi Outlander , 5dr SUV 03- 06 (EU)	- -	- -	- -	- -	- -	- -
Mitsubishi Outlander , 5dr SUV Feb 03-Jan 06 (AU)	- -	- -	- -	- -	- -	- -
Mitsubishi Pajero , 5dr SUV 00- 07 (EU)	-50mm -1 15/16ths"	700mm 27 9/16ths"	1450mm 57 1/16ths"	900mm 35 7/16ths"	900mm 35 7/16ths"	900mm 35 7/16ths"
Mitsubishi Pajero IO, 3dr SUV 99- 03 (ZA)	- -	- -	- -	- -	- -	- -
Mitsubishi Pajero io, 3dr SUV Jul 97-Jul 03 (NZ)	- -	- -	- -	- -	- -	- -
Mitsubishi Pajero io, 3dr SUV Mar 99-Jul 03 (AU)	- -	- -	- -	- -	- -	- -
Mitsubishi Pajero IO, 5dr SUV 99- 03 (ZA)	- -	- -	- -	- -	- -	- -
Mitsubishi Pajero io, 5dr SUV Mar 99-Jul 03 (AU)	- -	- -	- -	- -	- -	- -
Mitsubishi Pajero LWB, 5dr SUV 99- 06 (ZA)	-50mm -1 15/16ths"	700mm 27 9/16ths"	1450mm 57 1/16ths"	900mm 35 7/16ths"	900mm 35 7/16ths"	900mm 35 7/16ths"
Mitsubishi Pajero LWB, 5dr SUV Mar 07-+ (NZ)	-50mm -1 15/16ths"	700mm 27 9/16ths"	1450mm 57 1/16ths"	900mm 35 7/16ths"	900mm 35 7/16ths"	900mm 35 7/16ths"
Mitsubishi Pajero LWB, 5dr SUV May 00-Oct 06 (NZ)	-50mm -1 15/16ths"	700mm 27 9/16ths"	1450mm 57 1/16ths"	900mm 35 7/16ths"	900mm 35 7/16ths"	900mm 35 7/16ths"
Mitsubishi Pajero NM/NP, 5dr SUV May 00-Feb 07 (AU)	-50mm -1 15/16ths"	700mm 27 9/16ths"	1450mm 57 1/16ths"	900mm 35 7/16ths"	900mm 35 7/16ths"	900mm 35 7/16ths"
Mitsubishi Pajero NS, 5dr SUV Mar 07-+ (AU)	-50mm -1 15/16ths"	700mm 27 9/16ths"	1450mm 57 1/16ths"	900mm 35 7/16ths"	900mm 35 7/16ths"	900mm 35 7/16ths"
Mitsubishi Pajero SWB, 3dr SUV Jun 00-Feb 07 (AU)	-100mm -3 15/16ths"	670mm 26 3/8"	- -	900mm 35 7/16ths"	894mm 35 3/16ths"	- -
Mitsubishi Pajero SWB, 3dr SUV Jun 00-Oct 06 (NZ)	-100mm -3 15/16ths"	670mm 26 3/8"	- -	900mm 35 7/16ths"	894mm 35 3/16ths"	- -
Mitsubishi Pajero SWB, 3dr SUV Mar 07-+ (AU)	-100mm -3 15/16ths"	670mm 26 3/8"	- -	900mm 35 7/16ths"	894mm 35 3/16ths"	- -
Mitsubishi Pajero SWB, 3dr SUV Mar 07-+ (NZ)	-100mm -3 15/16ths"	670mm 26 3/8"	- -	900mm 35 7/16ths"	894mm 35 3/16ths"	- -
Mitsubishi Pinin , 5dr SUV 98-+ (EU)	- -	- -	- -	- -	- -	- -
Toyota Granvia , 4dr MPV 96-+ (AU)	500mm 19 11/16ths"	1100mm 43 5/16ths"	1720mm 67 11/16ths"	1036mm 40 13/16ths"	1036mm 40 13/16ths"	1036mm 40 13/16ths"
Toyota Granvia , 4dr MPV 96-+ (EU)	500mm 19 11/16ths"	1100mm 43 5/16ths"	1720mm 67 11/16ths"	1036mm 40 13/16ths"	1036mm 40 13/16ths"	1036mm 40 13/16ths"
Toyota Granvia , 4dr MPV 96-+ (NZ)	500mm 19 11/16ths"	1100mm 43 5/16ths"	1720mm 67 11/16ths"	1036mm 40 13/16ths"	1036mm 40 13/16ths"	1036mm 40 13/16ths"

Toyota Regius , 4dr MPV 97- 02 (NZ)

500mm	1100mm	1720mm	-	-	-
19 11/16ths"	43 5/16ths"	67 11/16ths"	-	-	-