

**GB** Fitting Instructions for Basic Carrier

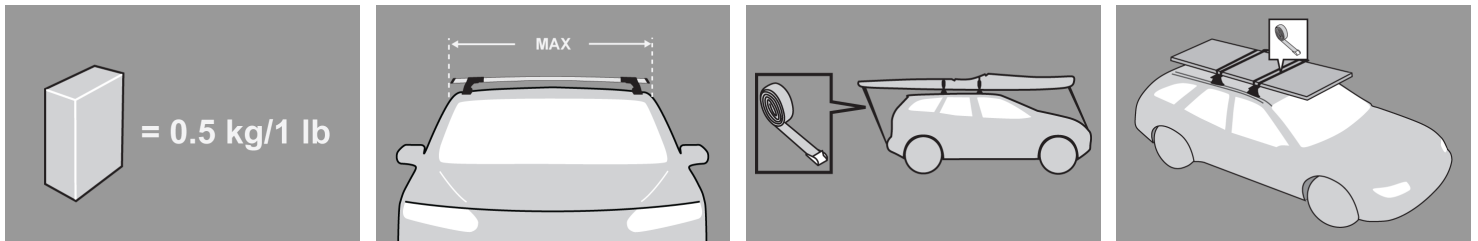

x 4

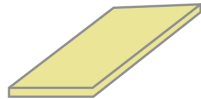

x 4



x 4



x 4



## MAX kgs

🚩 W/P WHD

### Chrysler

Town and Country , 5dr MPV 08-+ US 60 60

### Dodge

Grand Caravan , 5dr MPV 08-+ US 60 60

### Hyundai

H1 , 5dr Van 08-+ ZA 60 60

H1 Wagon, 5dr Van 08-+ ZA 60 60

iLoad , 5dr Van 08-+ EU 60 60

iLoad , 5dr Van Feb 08-+ AU 60 60

iMax , 5dr Van 09-+ NZ 60 60

### Volkswagen

Routan , 5dr MPV 09-+ US 40 40

## MAX kgs

🚩 W/P WHD

H1 , 5dr Van Feb 08- 09 NZ 60 60

i800 , 5dr Van 08-+ EU 60 60

iLoad , 5dr Van 09-+ NZ 60 60

iMax , 5dr Van 08-+ AU 60 60

## First Time Installation



- Remove parts from inside the package and check. Contact your dealer if any parts are missing or damaged.



- This kit fits type A, B, C and D.
- These instructions show type A crossbar fitted. They also apply to type B, C and D.

**NOTE: Clamp images in these instructions may not be representative of the clamps in this kit**



- Use keys to remove covers.



- Use hex screwdriver to reverse adjusting screw 10 turns.



- Press adjusting screw and pull crossbar legs out. Refer to the crossbar instructions for crossbar adjustment.
- Ensure each end of the crossbar is adjusted equally.



- Remove locking screw.

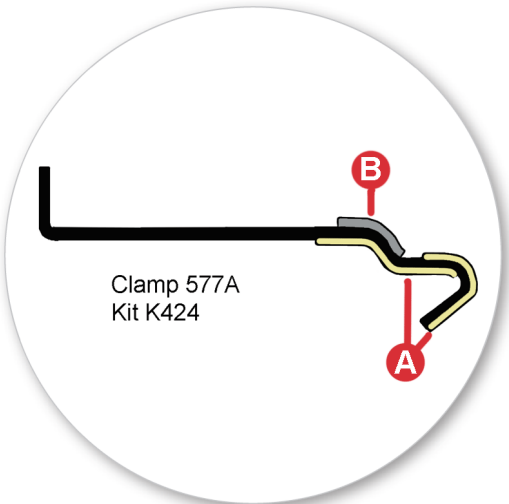

- Apply protective strip as shown. Trim if required.
- A= Clear
- B= Grey



- Attach clamp to each leg. NOTE; clamps may have labels showing their positions on the vehicle (For example; "Front Right").



- Refit locking screw so that it goes through the hole in the clamp. Do not begin to tighten the locking screw.



- Fit rubber pad (supplied with crossbar) to foot.



- Make sure the pad fits into the holes underneath the foot.

## Fitment



- Place crossbar on vehicle. Minimum recommended spacing between the bars is 700mm (27 1/2") (unless otherwise stated).
- Please check the rear of this manual for information relating specifically to your vehicle.



- Adjust the legs on the crossbar so that they are positioned equally from the ends of the crossbar, and the clamps engage firmly on the body work of the vehicle.
- Clamps over rubber door frame mouldings.



- Tighten adjusting screw to 5 Nm (3.7 ft lb).



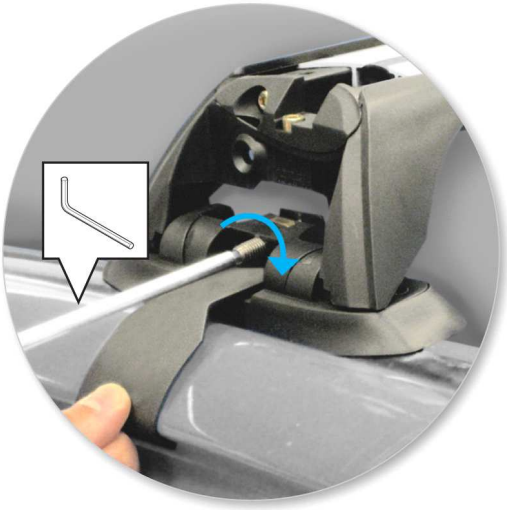

- Tighten locking screw on both legs evenly.



- Check crossbar is securely attached to the vehicle.



- Use keys to fit and lock covers



**CAUTION:**

**Recheck all fasteners immediately after a load is applied to the crossbars.**

**Regularly check screws are tight.**

---

## Maintenance

- Clean the car roof and surfaces of the product that will be in contact with the car roof.
- Follow the fitting instructions for fitting the product to your vehicle. Make sure all steps are carried out in order.
- Set crossbars a minimum distance of 700mm (27 1/2") apart where no other distance is specified in the fitting instructions. This is especially important when carrying long loads.
- Check unit is securely attached whenever you refit it to the vehicle. If the unit feels loose, refer to the fitting instructions and readjust.
- Some glass/panoramic roofs and radio antennae may not be able to be used when the product is fitted.
- Do not modify this product.
- Refer to the maximum permitted load capacity specified in the fitting instructions. Do not exceed the vehicle manufacturers roof load rating if it is lower than the maximum load capacity specified in the fitting instructions.
- Loads should not overhang the sides of the product and be evenly distributed with the lowest possible centre of gravity.
- Long loads should be secured with non-elastic straps to the front and rear of the vehicle.
- Objects with pointed ends (e.g. ski poles) should be carried with the pointed ends to the rear of the vehicle.
- Remove all loose or removable objects from the load prior to loading.
- Make sure all loads are securely fastened with non-elastic straps. Check regularly during longer journeys.

- A loaded roof rack system can alter the performance of your vehicle. Be especially aware of the effects of side winds, changing of direction, and braking performance. Avoid rapid acceleration and deceleration. Drive carefully.
- Note that the total height of the vehicle increases when upright loads are carried.
- Products should be locked during transport if they have locks fitted.
- Check and replace worn out or defective parts.
- Keep the product clean and maintained.
- Never drive into a car wash with the roof rack system fitted.
- Lubricate locks and adjusting screws at regular intervals.
- Remove the products from the vehicle when not in use. Make sure all loose parts are stored safely.

- 
- Hubco Automotive Ltd  
P. O. Box 11017  
Christchurch  
NEW ZEALAND

[www.whispbar.com](http://www.whispbar.com)  
[www.whispbar.com.au](http://www.whispbar.com.au)  
[www.whispbar.co.nz](http://www.whispbar.co.nz)  
[www.whispbar.co.uk](http://www.whispbar.co.uk)  
[www.whispbar.co.za](http://www.whispbar.co.za)  
[www.whispbar.eu](http://www.whispbar.eu)  
[www.whispbar.ca](http://www.whispbar.ca)

---

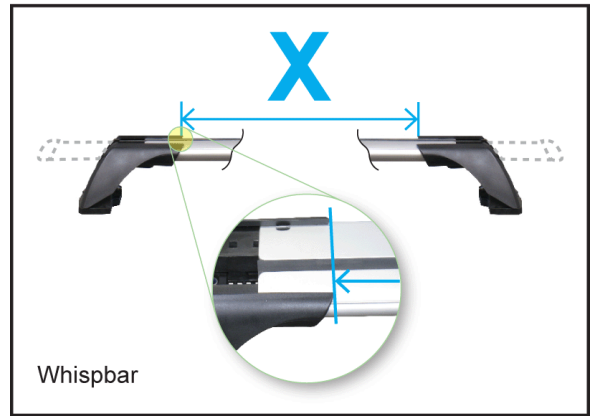
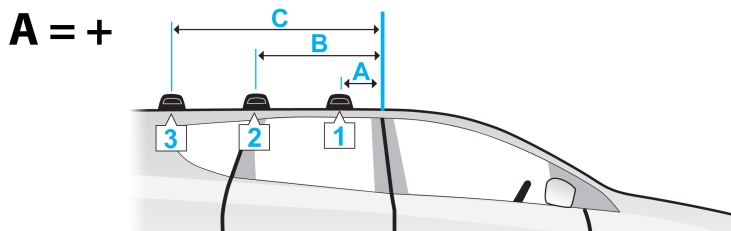
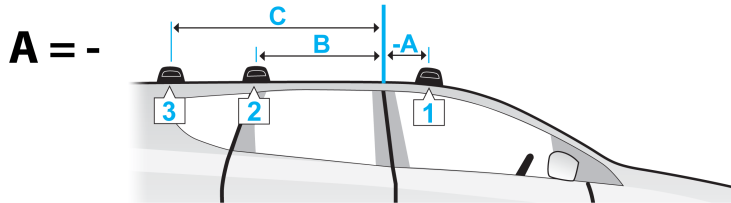

	X					
	A	B	C	1	2	3
Chrysler Town and Country , 5dr MPV 08+ (US)	200mm 7 7/8"	970mm 38 3/16ths"	-	1005mm 39 9/16ths"	975mm 38 3/8"	-
Dodge Grand Caravan , 5dr MPV 08+ (US)	200mm 7 7/8"	970mm 38 3/16ths"	-	1005mm 39 9/16ths"	975mm 38 3/8"	-
Hyundai H1 , 5dr Van 08+ (ZA)	150mm 5 7/8"	850mm 33 7/16ths"	-	1030mm 40 9/16ths"	1017mm 40 1/16ths"	-
Hyundai H1 , 5dr Van Feb 08- 09 (NZ)	150mm 5 7/8"	850mm 33 7/16ths"	-	1030mm 40 9/16ths"	1017mm 40 1/16ths"	-
Hyundai H1 Wagon, 5dr Van 08+ (ZA)	150mm 5 7/8"	850mm 33 7/16ths"	-	1030mm 40 9/16ths"	1017mm 40 1/16ths"	-
Hyundai i800 , 5dr Van 08+ (EU)	150mm 5 7/8"	850mm 33 7/16ths"	-	1030mm 40 9/16ths"	1017mm 40 1/16ths"	-
Hyundai iLoad , 5dr Van 08+ (EU)	150mm 5 7/8"	850mm 33 7/16ths"	-	1030mm 40 9/16ths"	1017mm 40 1/16ths"	-
Hyundai iLoad , 5dr Van 09+ (NZ)	150mm 5 7/8"	850mm 33 7/16ths"	-	1030mm 40 9/16ths"	1017mm 40 1/16ths"	-
Hyundai iLoad , 5dr Van Feb 08+ (AU)	150mm 5 7/8"	850mm 33 7/16ths"	-	1030mm 40 9/16ths"	1017mm 40 1/16ths"	-
Hyundai iMax , 5dr Van 08+ (AU)	150mm 5 7/8"	850mm 33 7/16ths"	-	1030mm 40 9/16ths"	1017mm 40 1/16ths"	-
Hyundai iMax , 5dr Van 09+ (NZ)	150mm 5 7/8"	850mm 33 7/16ths"	-	1030mm 40 9/16ths"	1017mm 40 1/16ths"	-
Volkswagen Routan , 5dr MPV 09+ (US)	200mm 7 7/8"	770mm 30 5/16ths"	-	1005mm 39 9/16ths"	975mm 38 3/8"	-