

GB Fitting Instruction for Accessory

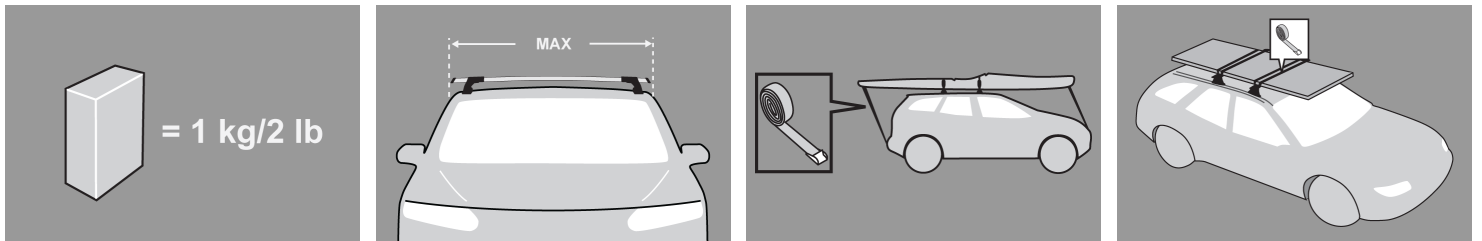

x 1

11-04-229

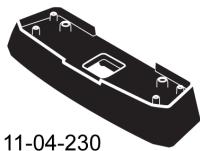

x 1

11-04-230

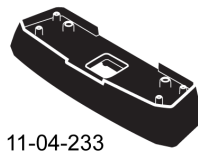

x 1

11-04-233

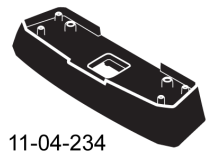

x 1

11-04-234



x 6

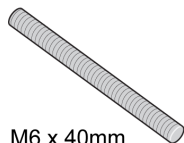

x 2

M6 x 40mm

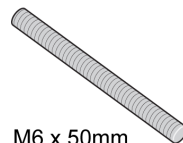

x 2

M6 x 50mm

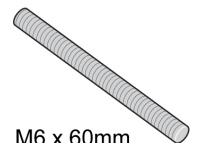

x 2

M6 x 60mm

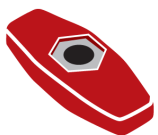

x 6

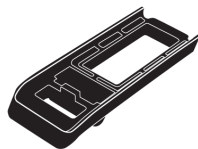

x 8

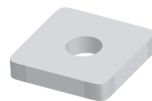

x 4

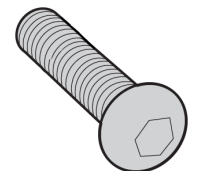

x 4



x 6

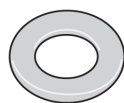

x 4

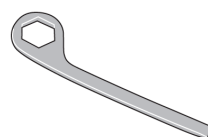

x 1

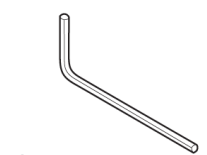

x 1

3 mm

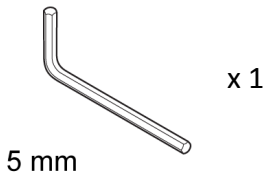



MAX kgs

W/P **WHD**

Citroen
 Berlingo LWB, 5dr Van 08-+
 Berlingo LWB, 5dr Van 08-+
 Peugeot
 Partner LWB, 5dr Van 08-+
 Partner LWB, 5dr Van 08-+
 Partner LWB, 5dr Van 08-+

EU	0	150
AU	0	150
ZA	0	150
EU	0	150
AU	0	150

MAX kgs

W/P **WHD**

Berlingo LWB, 5dr Van 08-+
 Partner LWB, 5dr Van 08-+
 Partner LWB, 5dr Van 08-+

NZ	0	150
US	0	150
NZ	0	150

First Time Installation



- Remove parts from inside the package and check. Contact your dealer if any parts are missing or damaged.



- This kit fits type D only.



- Use keys to remove covers.



- Remove Hex Key from right hand cover.

Front and rear crossbars only:



- Use the Hex Key to remove the endcap screw.



- Remove the endcap by pulling on the endcap pin and pushing on the top of the endcap. Use a side to side motion to assist.
- Repeat on other crossbar.



- Use hex screwdriver to reverse adjusting screw 10 turns.



- Press adjusting screw and slide the leg completely off the crossbar.



- Use the Hex Key to fully undo the adjusting screw.



- Remove the adjusting screw and store in a safe place.
- Repeat on both leg assemblies.



- Use the Hex Key to lift the toggle assembly.



- Remove the complete toggle assembly.



- Store items away in a safe place.



- Place two packers on each leg.
- Repeat on both leg assemblies.



- Insert the capscrew and washer together through the back of the leg.



- Assemble the nut onto the capscrew. Do Not Fully Tighten.



- Place leg assembly back onto crossbar. Ensure the nut goes into the bottom slot of the crossbar.
- Repeat on other crossbar.



- Carefully hold the endcap assembly and reinsert back onto the crossbar.
- Use the Hex Key to secure the endcap screw back into place.

Fitment

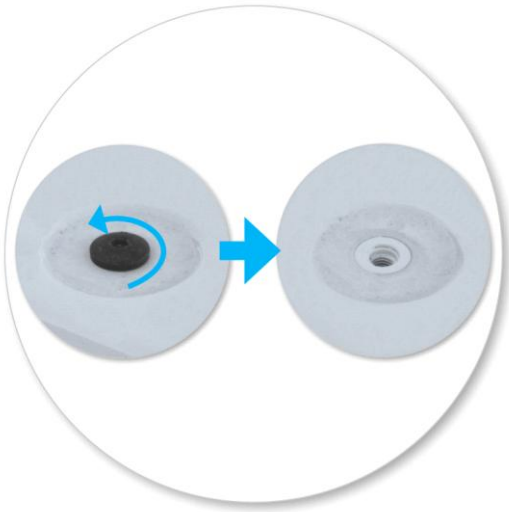

- Attaches to factory-fitted mounting points
- Open or remove fixed-point covers.



- Install adaptor onto vehicle.
- Repeat for all six positions.

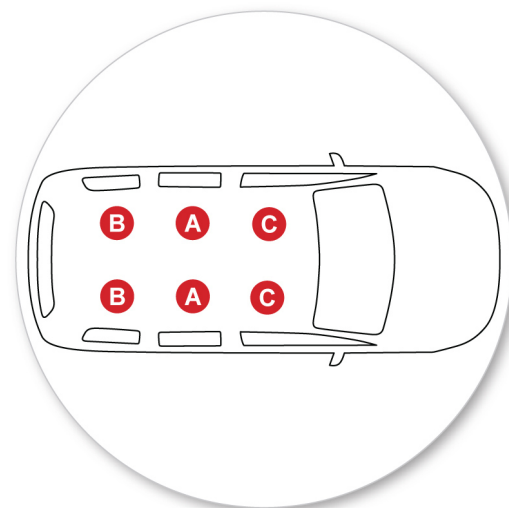

- It is important to put the grubscrews in the correct position on the vehicle.
- Use the following grubscrew lengths:
 - A = M6 x 40mm (1 5/8")
 - B = M6 x 50mm (2")
 - C = M6 x 60mm (2 3/8")



- Screw grub screw into adaptor using hex key. Tighten firmly.
- Repeat for all six positions.



- Refer to the underside of the pad for the part number.

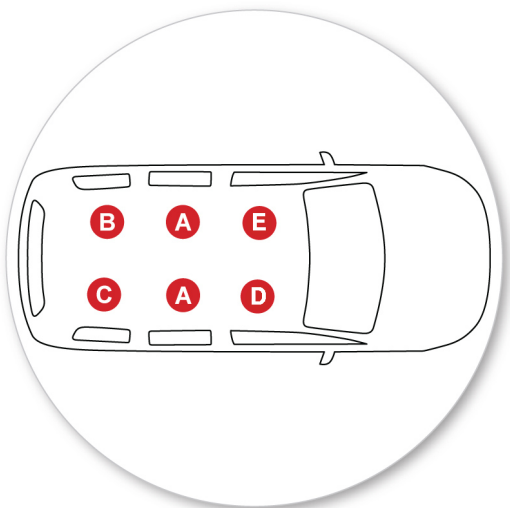

- It is important to put the pads in the correct position on the vehicle.
- Letters refer to the pad part numbers and position.
- Pad Part Number:
 Supplied with crossbars:
 A = 11-04-216
 Supplied in fitting kit box:
 B = 11-04-229
 C = 11-04-230
 D = 11-04-233
 E = 11-04-234



- Place pad over grub screw.
- Repeat for all six positions.

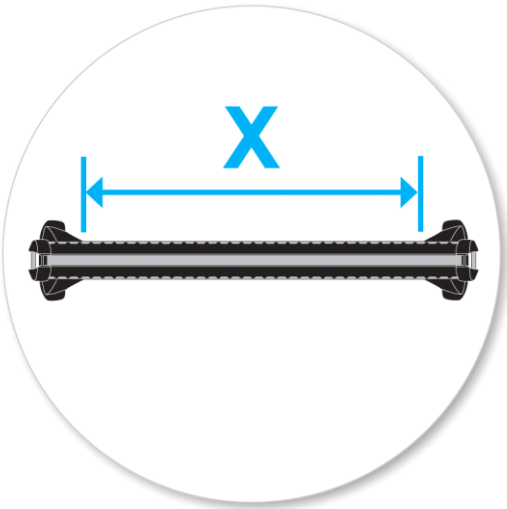

- Please check the rear of this manual for information relating specifically to your vehicle.
- Adjust crossbar in or out to suit vehicle. Refer to the crossbar instructions for crossbar adjustment.

Front and rear crossbars only:



- Ensure each end of the crossbar is adjusted equally.



- Using 5mm (1/4") Hex Key supplied with this kit, fully tighten to 5Nm (3.7 ft lb).

Centre crossbars only:



- Use the Hex Key to fully undo the adjusting screw.



- Press adjusting screw and pull crossbar legs out. Refer to the crossbar instructions for crossbar adjustment.
- Ensure each end of the crossbar is adjusted equally.



- Tighten adjusting screw to 5 Nm (3.7 ft lb).

All Crossbars:



- Remove plastic clamp block by gripping bar leg with fingers and push firmly with thumbs until clamp block drops out behind leg.



- Select plastic internal block (from fitting kit) and insert into foot.



- Place crossbars on pads ensuring the pads fit into the holes underneath the foot and the grub screw pass through the hole in the foot.



- Tighten the red plastic knob.



- Ensure the red plastic knob is in the position shown when fully tightened.
- Repeat for all six positions.



- Check crossbar is securely attached to the vehicle.



- Use keys to fit and lock covers

CAUTION:
Recheck all fasteners immediately after a load is applied to the crossbars.
Regularly check screws are tight.

Maintenance

- Clean the car roof and surfaces of the product that will be in contact with the car roof.
- Follow the fitting instructions for fitting the product to your vehicle. Make sure all steps are carried out in order.
- Set crossbars a minimum distance of 700mm (27 1/2") apart where no other distance is specified in the fitting instructions. This is especially important when carrying long loads.
- Check unit is securely attached whenever you refit it to the vehicle. If the unit feels loose, refer to the fitting instructions and readjust.
- Some glass/panoramic roofs and radio antennae may not be able to be used when the product is fitted.
- Do not modify this product.
- Refer to the maximum permitted load capacity specified in the fitting instructions. Do not exceed the vehicle manufacturers roof load rating if it is lower than the maximum load capacity specified in the fitting instructions.
- Loads should not overhang the sides of the product and be evenly distributed with the lowest possible centre of gravity.
- Long loads should be secured with non-elastic straps to the front and rear of the vehicle.
- Objects with pointed ends (e.g. ski poles) should be carried with the pointed ends to the rear of the vehicle.
- Remove all loose or removable objects from the load prior to loading.
- Make sure all loads are securely fastened with non-elastic straps. Check regularly during longer journeys.

- A loaded roof rack system can alter the performance of your vehicle. Be especially aware of the effects of side winds, changing of direction, and braking performance. Avoid rapid acceleration and deceleration. Drive carefully.
- Note that the total height of the vehicle increases when upright loads are carried.
- Products should be locked during transport if they have locks fitted.
- Check and replace worn out or defective parts.
- Keep the product clean and maintained.
- Never drive into a car wash with the roof rack system fitted.
- Lubricate locks and adjusting screws at regular intervals.
- Remove the products from the vehicle when not in use. Make sure all loose parts are stored safely.

-
- Hubco Automotive Ltd
P. O. Box 11017
Christchurch
NEW ZEALAND

www.whispbar.com
www.whispbar.com.au
www.whispbar.co.nz
www.whispbar.co.uk
www.whispbar.co.za
www.whispbar.eu
www.whispbar.ca

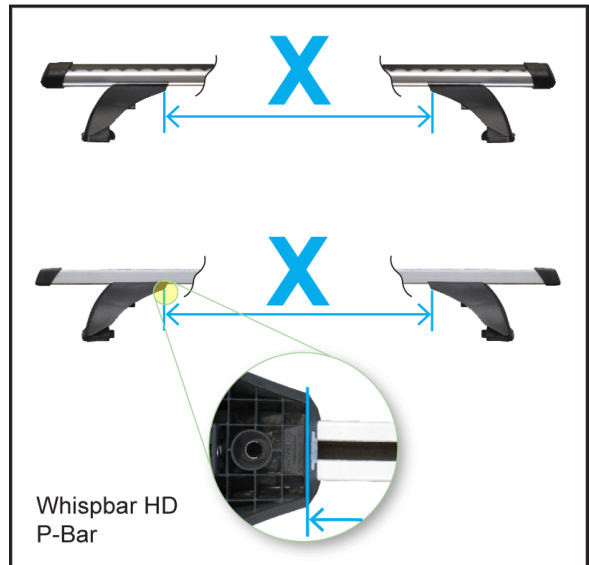
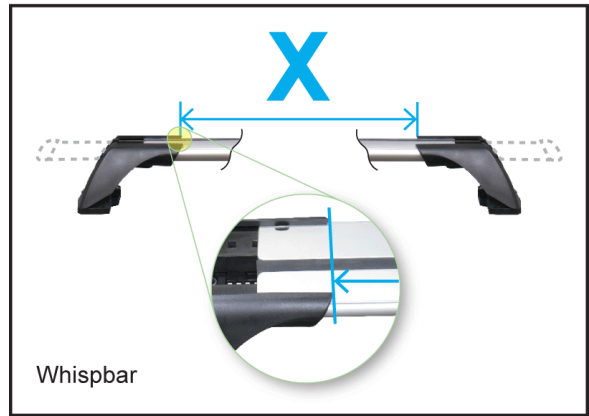
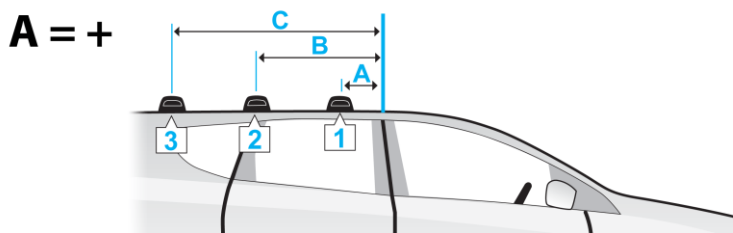
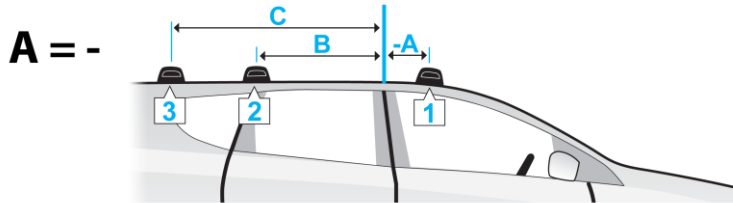

	A	B	C	X		
				1	2	3
Citroen Berlingo LWB, 5dr Van 08+ (AU)	-180mm -7 1/16ths"	670mm 26 3/8"	1370mm 53 15/16ths"	985mm 38 3/4"	945mm 37 3/16ths"	915mm 36 "
Citroen Berlingo LWB, 5dr Van 08+ (EU)	-180mm -7 1/16ths"	670mm 26 3/8"	1370mm 53 15/16ths"	985mm 38 3/4"	945mm 37 3/16ths"	915mm 36 "
Citroen Berlingo LWB, 5dr Van 08+ (NZ)	-180mm -7 1/16ths"	670mm 26 3/8"	1370mm 53 15/16ths"	985mm 38 3/4"	945mm 37 3/16ths"	915mm 36 "
Peugeot Partner LWB, 5dr Van 08+ (AU)	-180mm -7 1/16ths"	670mm 26 3/8"	1370mm 53 15/16ths"	985mm 38 3/4"	945mm 37 3/16ths"	915mm 36 "
Peugeot Partner LWB, 5dr Van 08+ (EU)	-180mm -7 1/16ths"	670mm 26 3/8"	1370mm 53 15/16ths"	985mm 38 3/4"	945mm 37 3/16ths"	915mm 36 "
Peugeot Partner LWB, 5dr Van 08+ (NZ)	-180mm -7 1/16ths"	670mm 26 3/8"	1370mm 53 15/16ths"	985mm 38 3/4"	945mm 37 3/16ths"	915mm 36 "
Peugeot Partner LWB, 5dr Van 08+ (US)	-180mm -7 1/16ths"	670mm 26 3/8"	1370mm 53 15/16ths"	985mm 38 3/4"	945mm 37 3/16ths"	915mm 36 "
Peugeot Partner LWB, 5dr Van 08+ (ZA)	-180mm -7 1/16ths"	670mm 26 3/8"	1370mm 53 15/16ths"	985mm 38 3/4"	945mm 37 3/16ths"	915mm 36 "