

Kit 1014

BMW 3-Series Compact, 3-dr Coupé, 94-00 / *95-00

BMW 3-Series, 4-dr Sedan, 91-97 / *92-98

BMW 3-Series Touring, 5-dr Estate, 96-99

BMW 3-Series, 5-dr Wagon, *96-99

*North America

480R
754

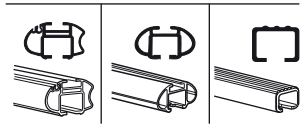
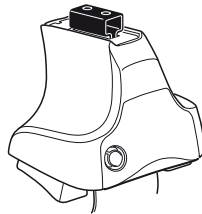

480

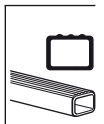
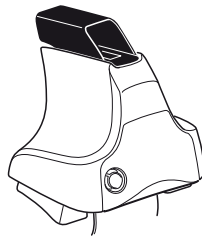

750

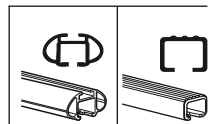
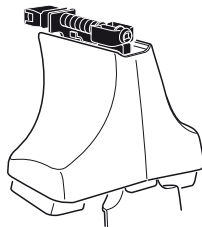

BMW 3-Series Compact, 3-dr Coupé, '94-00 / '95-00

Max.
60kg/132 lbs



BMW 3-Series, 4-dr Sedan, '91-97 / '92-98
BMW 3-Series Touring, 5-dr Estate, '96-99
BMW 3-Series, 5-dr Wagon, '96-99

Max.
75kg/165 lbs



THULE



Kit XXXX
instructions

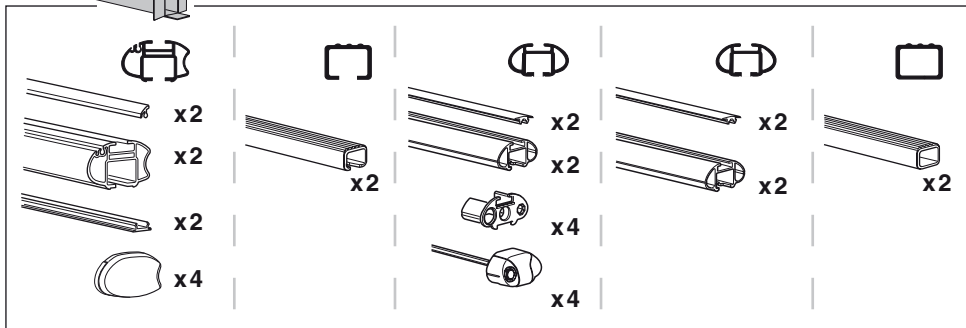
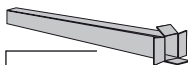
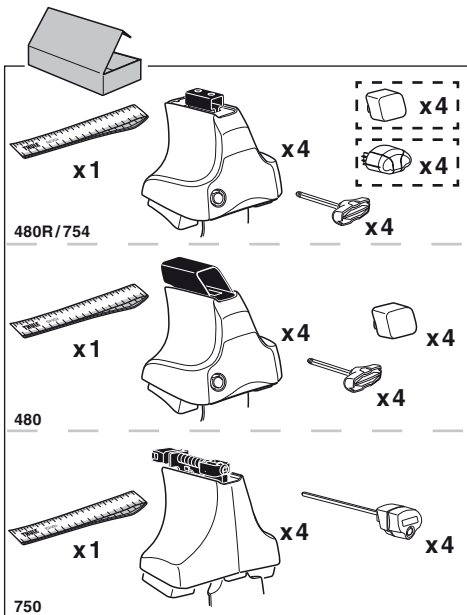

222 x4

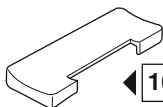

16 x4



71 x2

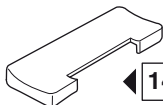

14 x2



x1

Kit

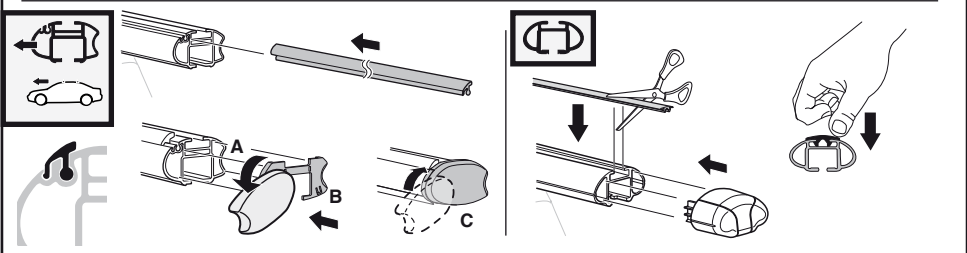
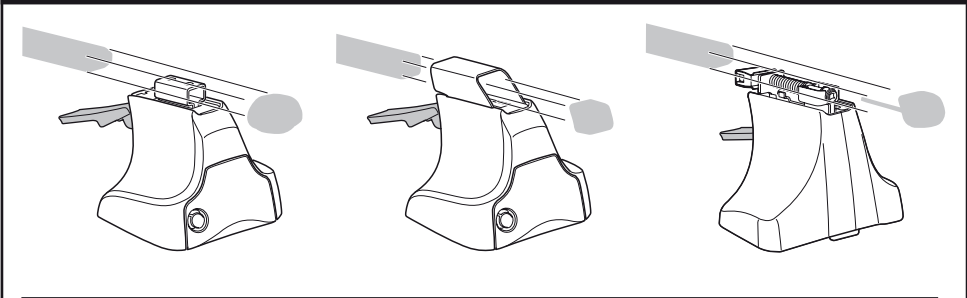

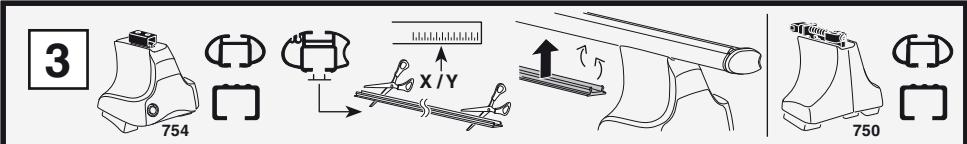

1

2

	X
BMW 3-Series Compact, 3-dr Coupé, 94-00 / *95-00	26
BMW 3-Series, 4-dr Sedan, 91-97 / *92-98	26,5
BMW 3-Series Touring, 5-dr Estate, 96-99	26,5
BMW 3-Series, 5-dr Wagon, *96-99	26,5

1

2

	Y
BMW 3-Series Compact, 3-dr Coupé, 94-00 / *95-00	28
BMW 3-Series, 4-dr Sedan, 91-97 / *92-98	23
BMW 3-Series Touring, 5-dr Estate, 96-99	22,5
BMW 3-Series, 5-dr Wagon, *96-99	22,5

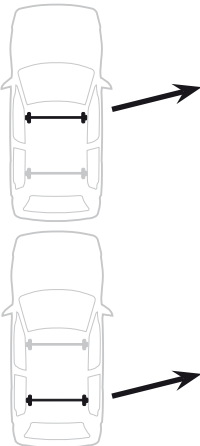
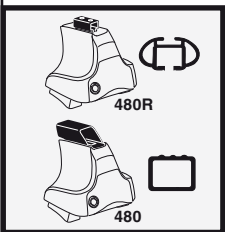

1

2

	X inch	X mm
BMW 3-Series Compact, 3-dr Coupé, 94-00 / *95-00	35 ⁷/₈ "	911 mm
BMW 3-Series, 4-dr Sedan, 91-97 / *92-98	36 ¹/₈ "	916 mm
BMW 3-Series Touring, 5-dr Estate, 96-99	36 ¹/₈ "	916 mm
BMW 3-Series, 5-dr Wagon, *96-99	36 ¹/₈ "	916 mm

1

2

	X inch	X mm
BMW 3-Series Compact, 3-dr Coupé, 94-00 / *95-00	36 ⁵/₈ "	931 mm
BMW 3-Series, 4-dr Sedan, 91-97 / *92-98	34 ⁵/₈ "	881 mm
BMW 3-Series Touring, 5-dr Estate, 96-99	34 ¹/₂ "	876 mm
BMW 3-Series, 5-dr Wagon, *96-99	34 ¹/₂ "	876 mm

4

BMW 3-Series Compact, 3-dr Coupé, 94-00 / *95-00

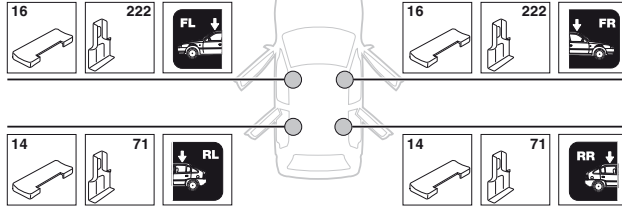

BMW 3-Series, 4-dr Sedan, 91-97 / *92-98

BMW 3-Series Touring, 5-dr Estate, 96-99

BMW 3-Series, 5-dr Wagon, *96-99

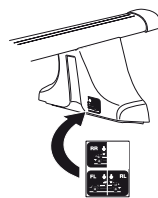
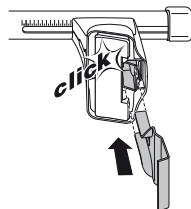
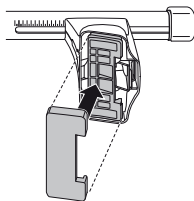
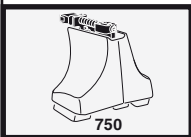
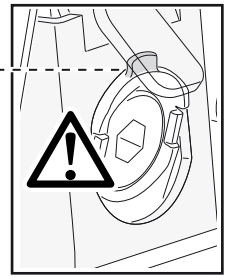
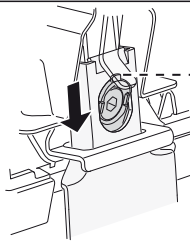
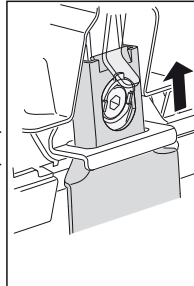
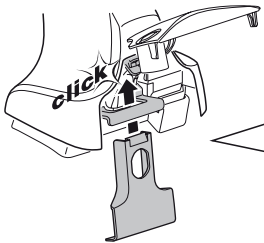
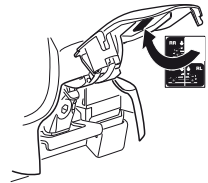
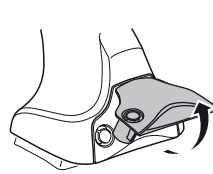
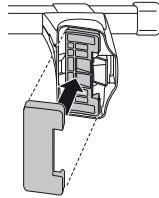
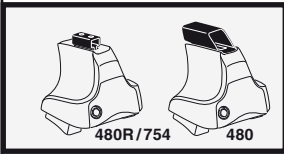
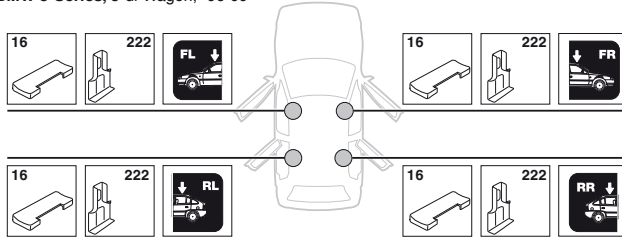

5

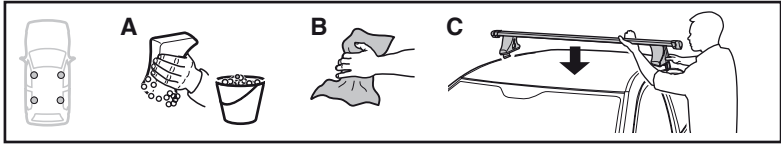

BMW 3-Series Compact, 3-dr Coupé, 94-00 / *95-00

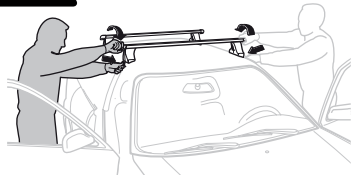
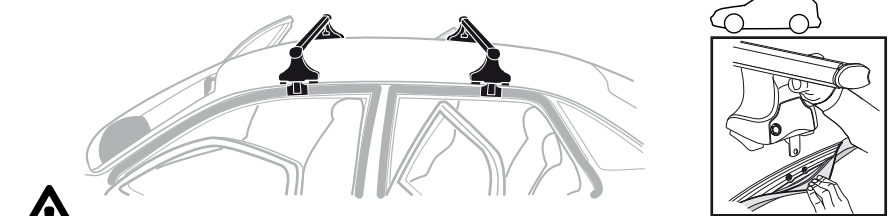
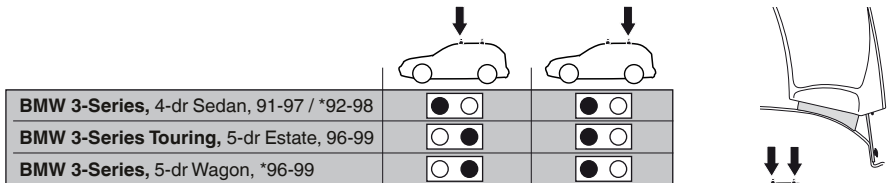
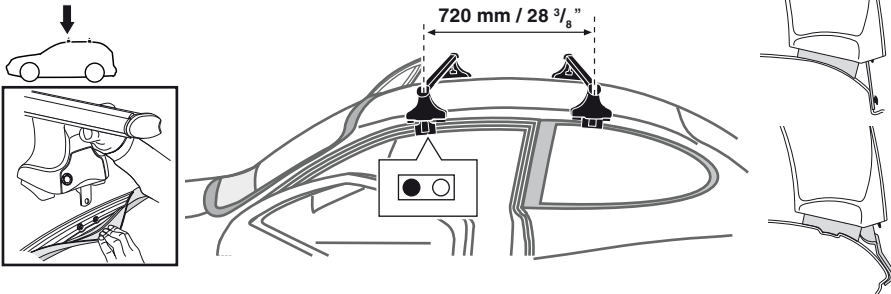

- GB/US** Tighten alternately
D Die Schrauben abwechselnd anziehen
F Serrer alternativement chaque côté
NL Afwisselend aan de linker- en de rechterkant aandraaien
I Alternare il serraggio delle viti
E Serrare alternativamente
PT Aperte alternadamente
S Dra åt växelsvis

- FIN** Kierrä vuorotellen
EST Pinguldage vaheldumisi
LAT Pievelciēt pamīšus
LIT Užsukinėkite pakaitomis
PL Śruby dokręcaj naprzemiennie
RU Затягивайте попеременно
CZ Pokręťta багаžníka dokręcaj dokręcaj naprzemiennie.
SK Doťahujte striedavo
SLO Privijajte izmenično.
HR Naizmjenično zategnite
HU Egymástól függetlenül szorítandó
GR Σφίγγετε εναλλάξ
TR Dönüşümlü sıkın
中文 交替拧紧
한국어 번갈아 가며 조이십시오.
日本語 交互に締め付けてください。
ไทย ชั้นในแบบสลับ

6



480R/754



480

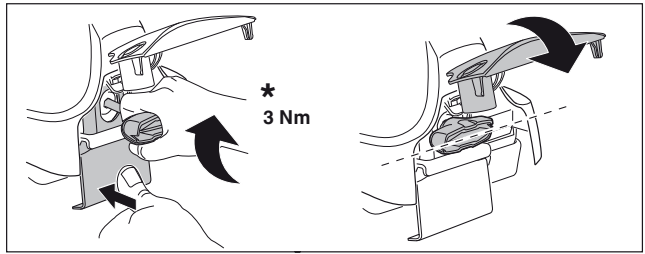
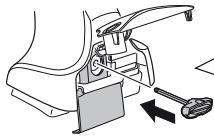

*
3 Nm

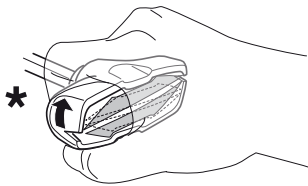

*

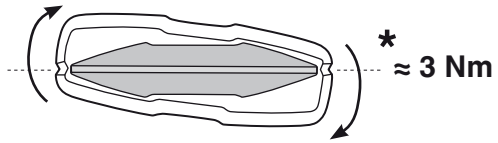

*
≈ 3 Nm

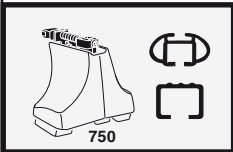
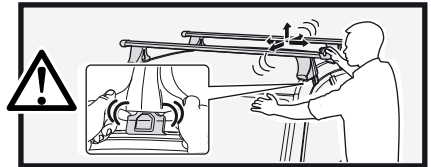

750

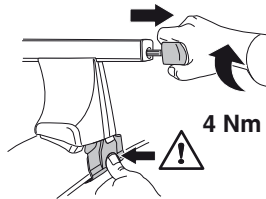

4 Nm

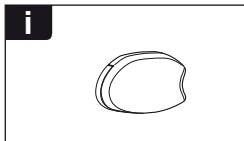
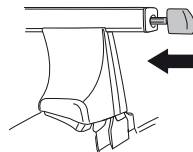

i

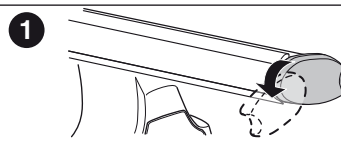

1

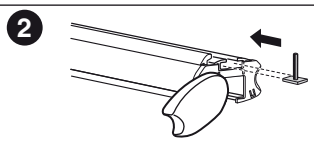

2

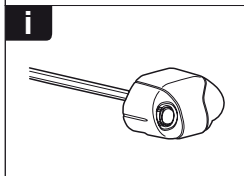

i

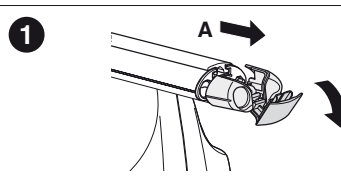

1

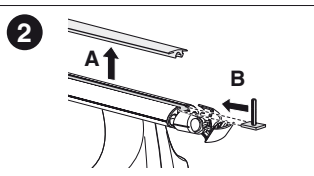

2

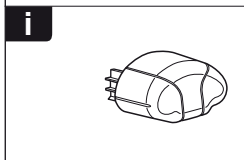

i

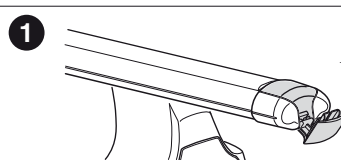

1

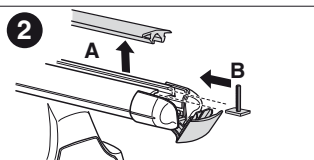

2

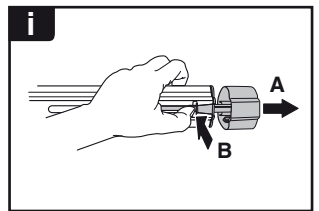
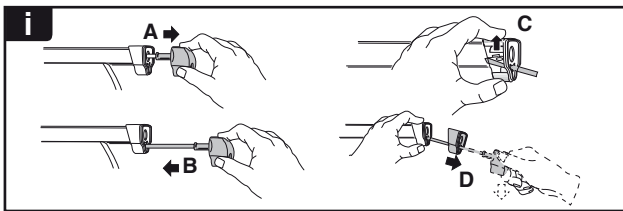
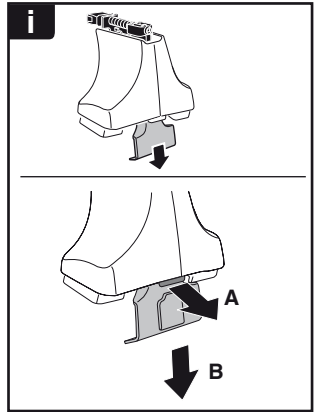
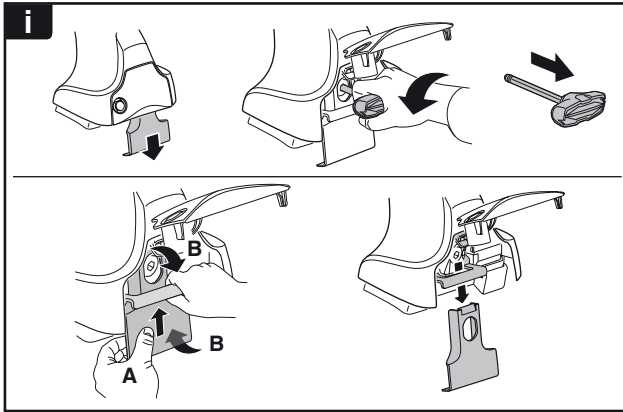
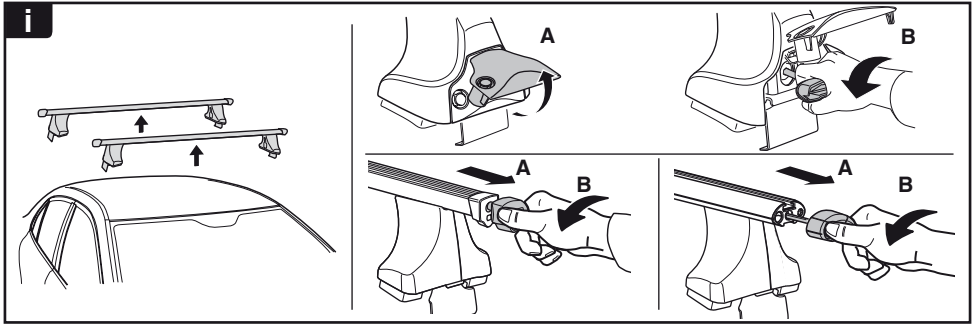

THULE
SWEDEN
**ONE
KEY
SYSTEM**

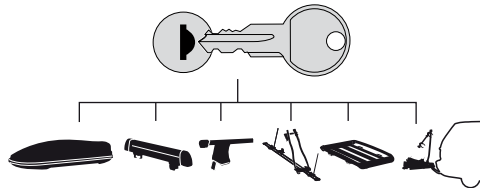

- 544 (x4)
- 596 (x6)
- 588 (x8)
- NA 510 (x10)
- EUR 452 (x12)
- ASIA

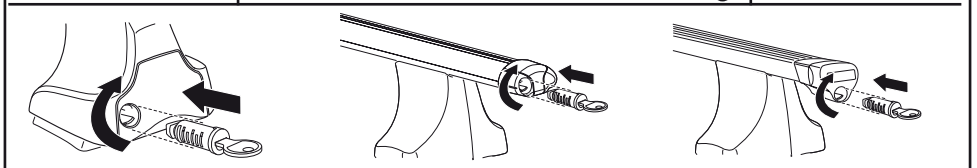

WW ▶ Thule Sweden AB, Box 69, 330 33 Hillerstorp, SWEDEN
NA ▶ Thule Inc., 42 Silvermine Road, Seymour, Connecticut 06483, USA

info@thule.com
customer.service@thule.com

www.thule.com