

# Kit 1184

**CITROËN Berlingo**, 3-dr Van, 97-02, 03-08

**CITROËN Xsara Picasso**, 5-dr MPV, 00-03, 04-06\*

**PEUGEOT Partner**, 3/4/5-dr Van, 97-02, 03-08

**PEUGEOT Ranch**, 3/4/5-dr Van, 97-02, 03-08

\* without sunroof

480R  
754

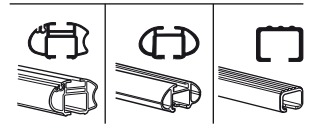
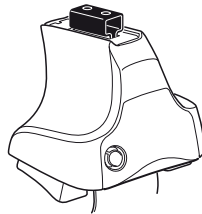

480

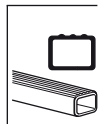
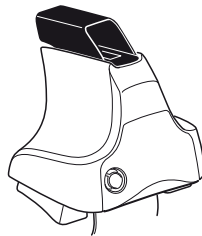

750

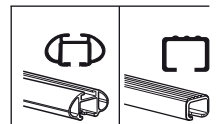
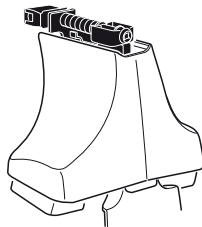

**THULE**<sup>®</sup>  
SWEDEN

ISO 11154-E

x2 x2 x2 x4	x2	x2 x2 x4 x4	x2 x2	x2

**346** x 4

**22** x 4

x 1

**Kit**



**3**



754

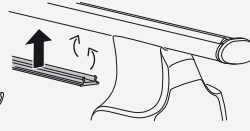
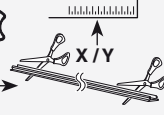

750

**1**

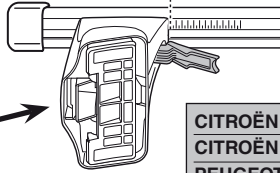
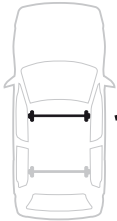

**2**

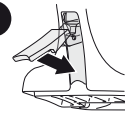

	X
<b>CITROËN Berlingo, 3-dr Van, 97-02, 03-08</b>	<b>23,5</b>
<b>CITROËN Xsara Picasso, 5-dr MPV, 00-03, 04-06</b>	<b>21</b>
<b>PEUGEOT Partner, 3/4/5-dr Van, 97-02, 03-08</b>	<b>23,5</b>
<b>PEUGEOT Ranch, 3/4/5-dr Van, 97-02, 03-08</b>	<b>23,5</b>

**1**

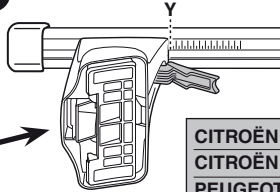
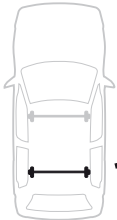

**2**

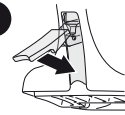

	Y
<b>CITROËN Berlingo, 3-dr Van, 97-02, 03-08</b>	<b>24</b>
<b>CITROËN Xsara Picasso, 5-dr MPV, 00-03, 04-06</b>	<b>20</b>
<b>PEUGEOT Partner, 3/4/5-dr Van, 97-02, 03-08</b>	<b>24</b>
<b>PEUGEOT Ranch, 3/4/5-dr Van, 97-02, 03-08</b>	<b>24</b>



480R



480

**1**

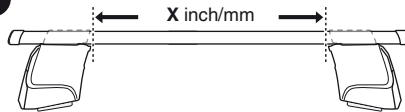

**2**

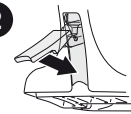

	X inch	X mm
<b>CITROËN Berlingo, 3-dr Van, 97-02, 03-08</b>	<b>34 <sup>7</sup>/<sub>8</sub> "</b>	<b>886 mm</b>
<b>CITROËN Xsara Picasso, 5-dr MPV, 00-03, 04-06</b>	<b>33 <sup>7</sup>/<sub>8</sub> "</b>	<b>861 mm</b>
<b>PEUGEOT Partner, 3/4/5-dr Van, 97-02, 03-08</b>	<b>34 <sup>7</sup>/<sub>8</sub> "</b>	<b>886 mm</b>
<b>PEUGEOT Ranch, 3/4/5-dr Van, 97-02, 03-08</b>	<b>34 <sup>7</sup>/<sub>8</sub> "</b>	<b>886 mm</b>

**1**

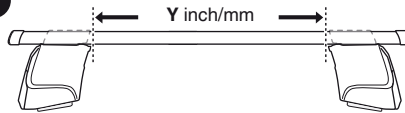

**2**

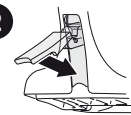

	Y inch	Y mm
<b>CITROËN Berlingo, 3-dr Van, 97-02, 03-08</b>	<b>35 <sup>1</sup>/<sub>8</sub> "</b>	<b>891 mm</b>
<b>CITROËN Xsara Picasso, 5-dr MPV, 00-03, 04-06</b>	<b>33 <sup>1</sup>/<sub>2</sub> "</b>	<b>851 mm</b>
<b>PEUGEOT Partner, 3/4/5-dr Van, 97-02, 03-08</b>	<b>35 <sup>1</sup>/<sub>8</sub> "</b>	<b>891 mm</b>
<b>PEUGEOT Ranch, 3/4/5-dr Van, 97-02, 03-08</b>	<b>35 <sup>1</sup>/<sub>8</sub> "</b>	<b>891 mm</b>

# 4

CITROËN Berlingo, 3-dr Van, 97-02, 03-08

CITROËN Xsara Picasso, 5-dr MPV, 00-03, 04-06

PEUGEOT Partner, 3/4/5-dr Van, 97-02, 03-08

PEUGEOT Ranch, 3/4/5-dr Van, 97-02, 03-08

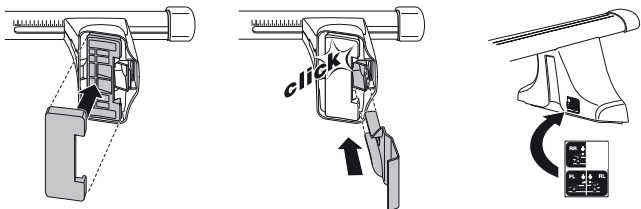
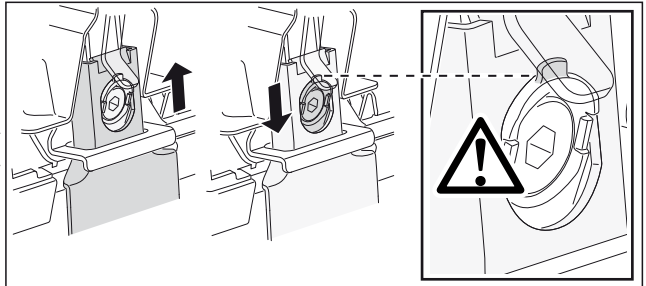
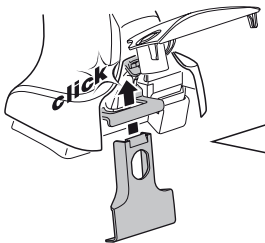
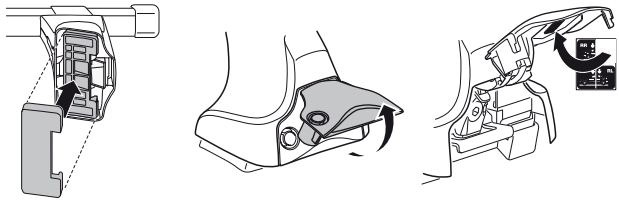
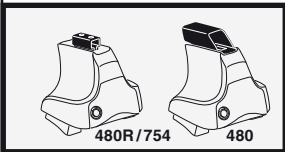
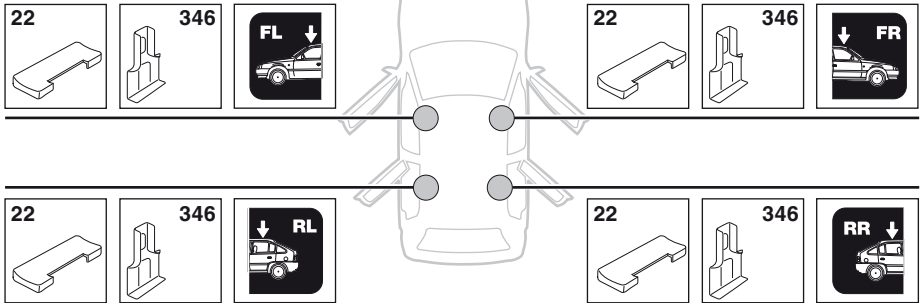

5

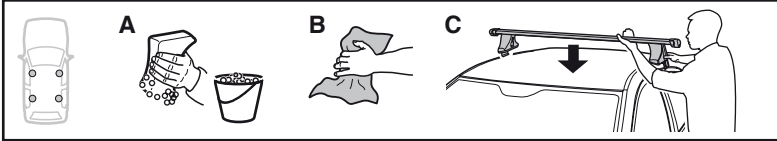

	X mm	Y mm	X inch	Y inch
<b>CITROËN Berlingo</b> , 3-dr Van, 97-02, 03-08	770 mm	600 mm	30 <sup>3</sup> / <sub>8</sub> "	23 <sup>5</sup> / <sub>8</sub> "
<b>CITROËN Xsara Picasso</b> , 5-dr MPV, 00-03, 04-06	320 mm	700 mm	12 <sup>5</sup> / <sub>8</sub> "	27 <sup>1</sup> / <sub>2</sub> "
<b>PEUGEOT Partner</b> , 3/4/5-dr Van, 97-02, 03-08	770 mm	600 mm	30 <sup>3</sup> / <sub>8</sub> "	23 <sup>5</sup> / <sub>8</sub> "
<b>PEUGEOT Ranch</b> , 3/4/5-dr Van, 97-02, 03-08	770 mm	600 mm	30 <sup>3</sup> / <sub>8</sub> "	23 <sup>5</sup> / <sub>8</sub> "

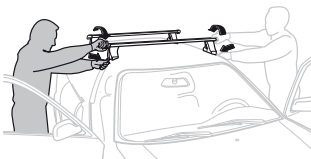
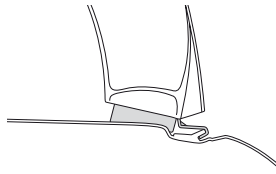
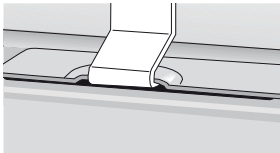
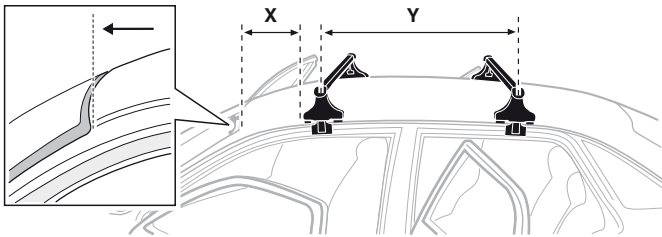

- |              |   |            |  |
|--------------|---|------------|--|
| <b>GB/US</b> | Tighten alternately                                     | <b>CZ</b>  | Pokřeřta багажника докрeçaj dokrëçaj naprziemiennie. |
| <b>D</b>     | Die Schrauben abwechselnd anziehen                      | <b>SK</b>  | Dofahujte striedavo                                  |
| <b>F</b>     | Serrer alternativement chaque côté                      | <b>SLO</b> | Privijajte izmenično.                                |
| <b>NL</b>    | Afwisselend aan de linker- en de rechterkant aandraaien | <b>HR</b>  | Naizmjenično zategnite                               |
| <b>I</b>     | Alternare il serraggio delle viti                       | <b>HU</b>  | Egymástól függetlenül szorítandó                     |
| <b>E</b>     | Apretar alternativamente                                | <b>GR</b>  | Σφιγίγστε εναλλάξ                                    |
| <b>PT</b>    | Aperte alternadamente                                   | <b>TR</b>  | Dönüşümlü sıkın                                      |
| <b>S</b>     | Dra åt växelvis   | <b>中文</b>  | 交替拧紧   |
| <b>FIN</b>   | Kierrä vuorotellen                                      | <b>한국어</b> | 빈갈아 가며 조이십시오.  |
| <b>EST</b>   | Pinguldage vaheldumisi                                  | <b>日本語</b> | 交互に締め付けてください。  |
| <b>LAT</b>   | Pielvelciet pamišus                                     | <b>ไทย</b> | ขันในแบบสลับ   |
| <b>LIT</b>   | Užsukinėkite pakaitomis                                 |            |  |
| <b>PL</b>    | Śruby dokrëçaj naprziemiennie                           |            |  |
| <b>RU</b>    | Затягивайте попеременно                                 |            |  |

6



480R/754



480

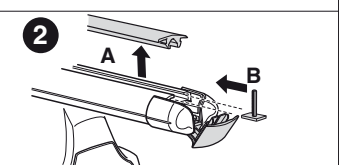
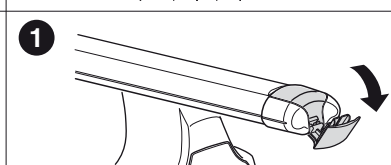
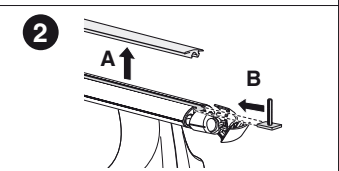
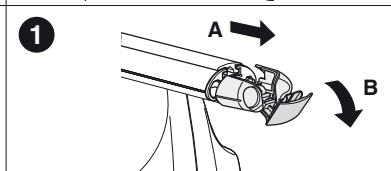
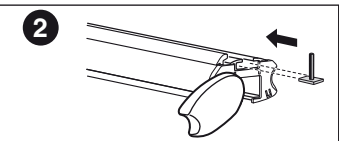
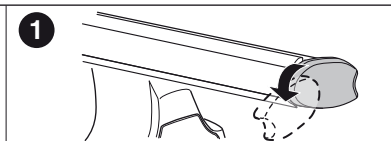
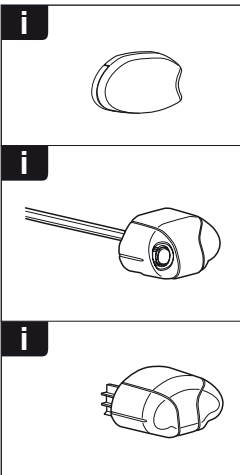
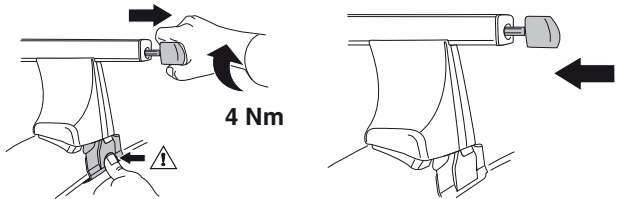
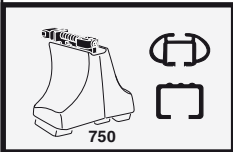
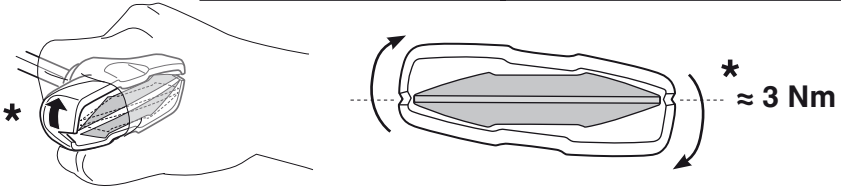
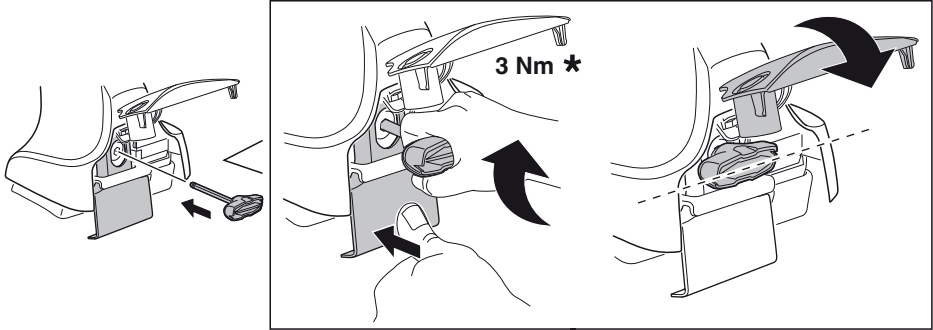

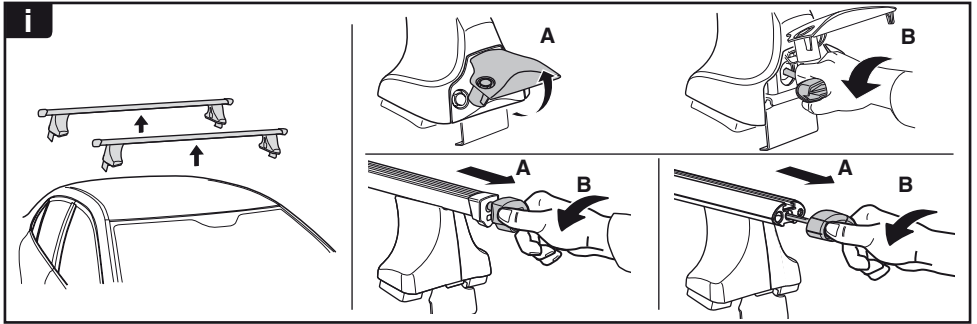

**THULE**  
SWEDEN  
**ONE  
KEY  
SYSTEM**



		(x4)
		(x6)
		(x8)
NA		(x10)
EUR		(x12)
ASIA		(x12)



WW ▶ Thule Sweden AB, Box 69, 330 33 Hillerstorp, SWEDEN  
NA ▶ Thule Inc., 42 Silvermine Road, Seymour, Connecticut 06483, USA

info@thule.com  
customer.service@thule.com

www.thule.com



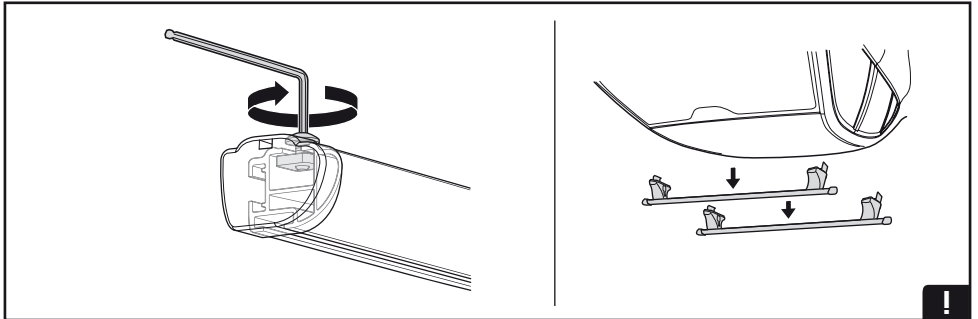
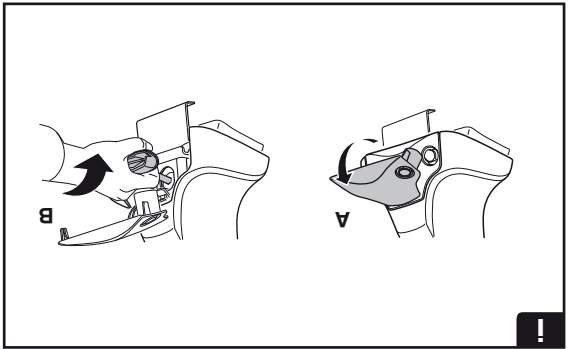
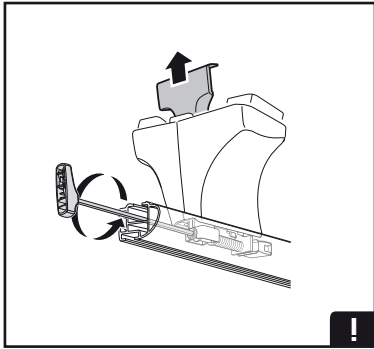
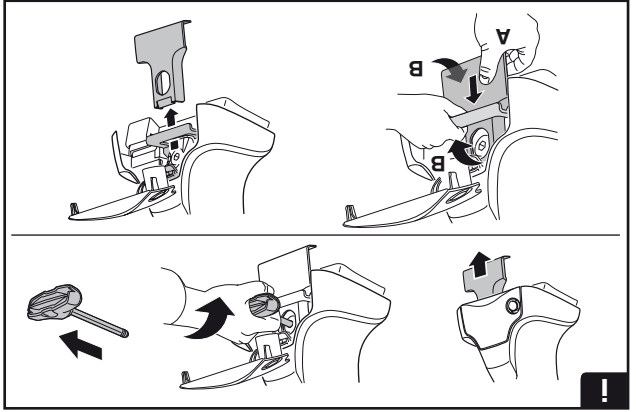
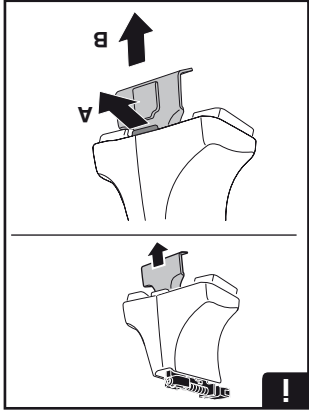

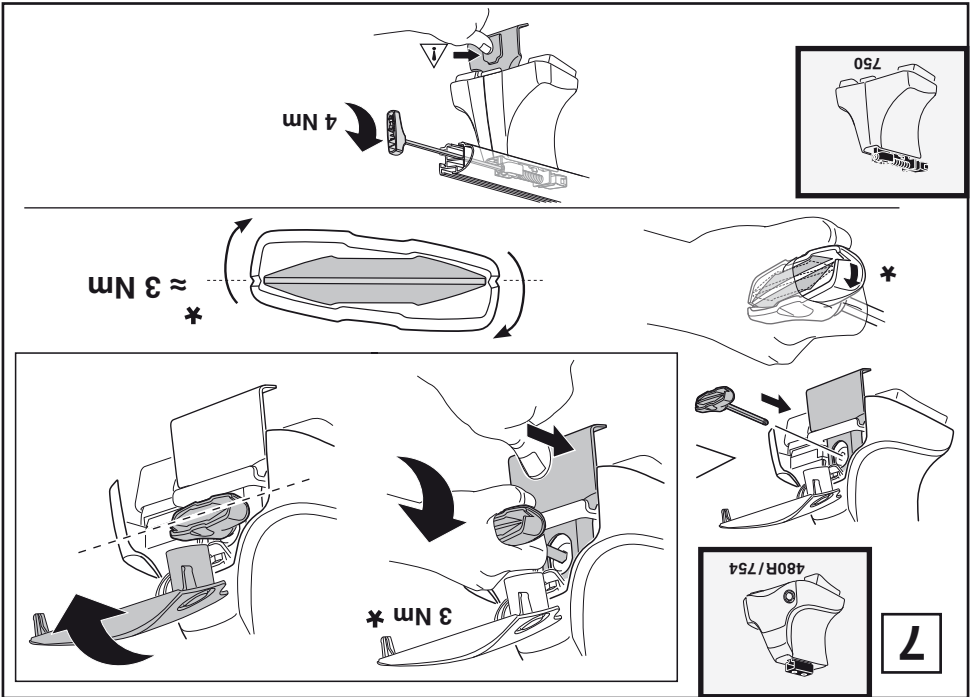
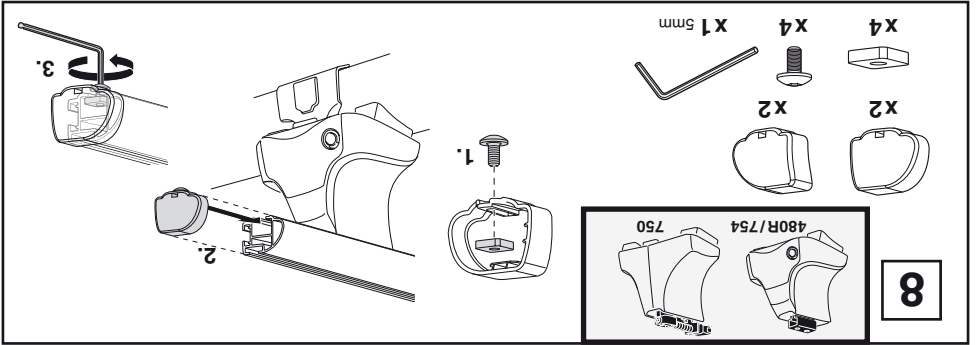
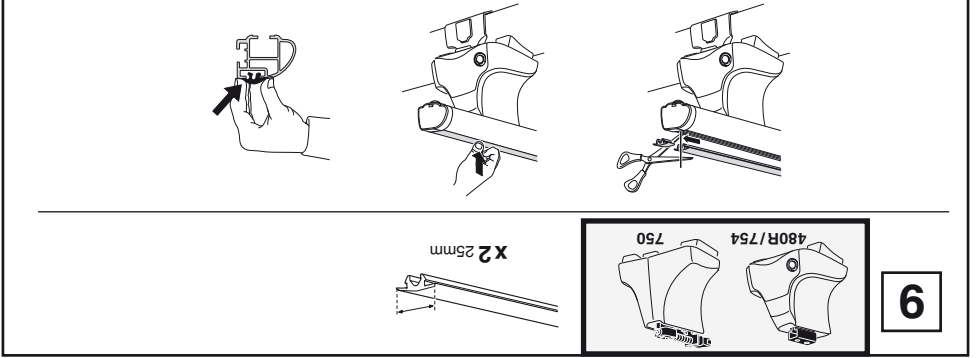

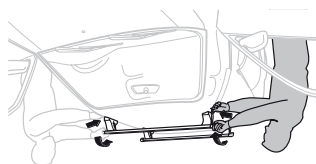

GB/US Tighen alternativ  
D Die Schrauben abwechselnd  
anziehen  
F Serrer alternativement chaque côté  
NL Afwisselend aan de linker- en de  
rechterkant aandraaien  
I Alternare il serraggio delle viti  
E Apretar alternativamente  
PT Aperte alternadamente  
S Dra åt växelvis  
FIN Kierra vuorotellen  
EST Pinguldage vaheldumisi  
LAT Pļevcliet pamēstus  
LT Užskinkite pakaitomis  
PL Śruby dokrecaj naprzemiennie  
RU Затягивайте попеременно

CZ Pokrýtá bagazníka dokrecaj  
SK Dotiahnuť striedavo  
SLO Privaľaje izmenično.  
HR Najzamenično zategniti  
HU Egymástól fűggetlenül  
GR Zφtyyete evadák  
TR Dönüştürmü iskin  
中文 交替拧紧  
한국어 번갈아 가며 조이십시오.  
日本語 交互に締め付けてください。

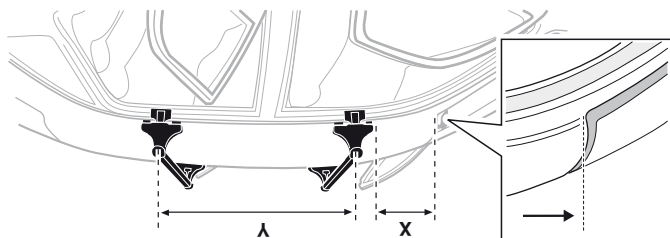
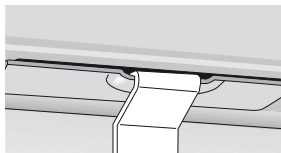
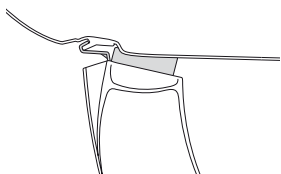

CITROËN Berlingo, 3-dr Van, 97-02, 03-08	770 mm	600 mm	30 3/8"	23 5/8"
CITROËN Xsara Picasso, 5-dr MPV, 00-03, 04-06	320 mm	700 mm	12 5/8"	27 1/2"
PEUGEOT Partner, 3/4-5-dr Van, 97-02, 03-08	770 mm	600 mm	30 3/8"	23 5/8"
PEUGEOT Ranch, 3/4-5-dr Van, 97-02, 03-08	770 mm	600 mm	30 3/8"	23 5/8"

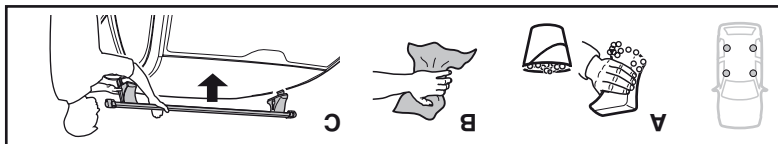

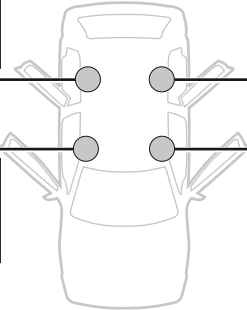
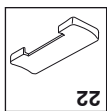
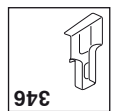
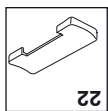
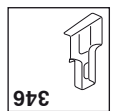
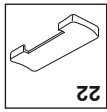
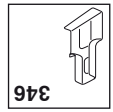
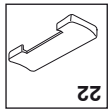
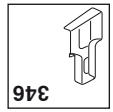
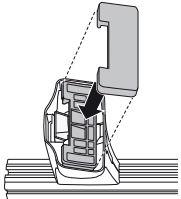
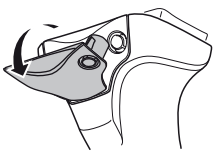
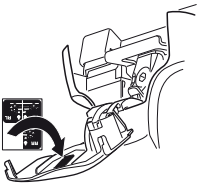
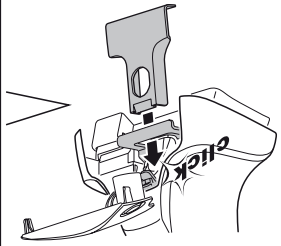
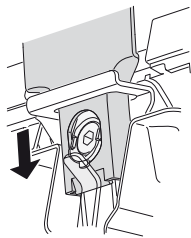
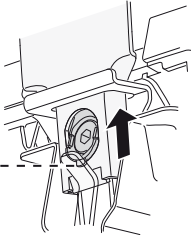
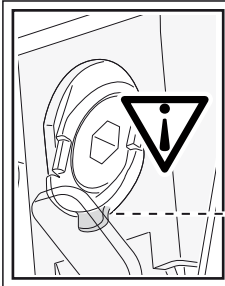
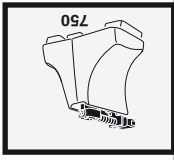
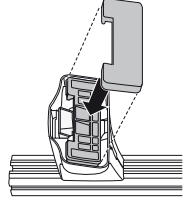
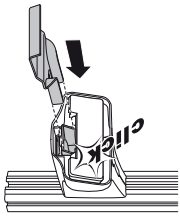
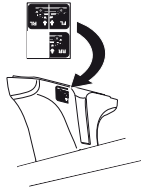

CITROËN Berlingo, 3-dr Van, 97-02, 03-08  
CITROËN Xsara Picasso, 5-dr MPV, 00-03, 04-06  
PEUGEOT Partner, 3/4-5-dr Van, 97-02, 03-08  
PEUGEOT Ranch, 3/4-5-dr Van, 97-02, 03-08

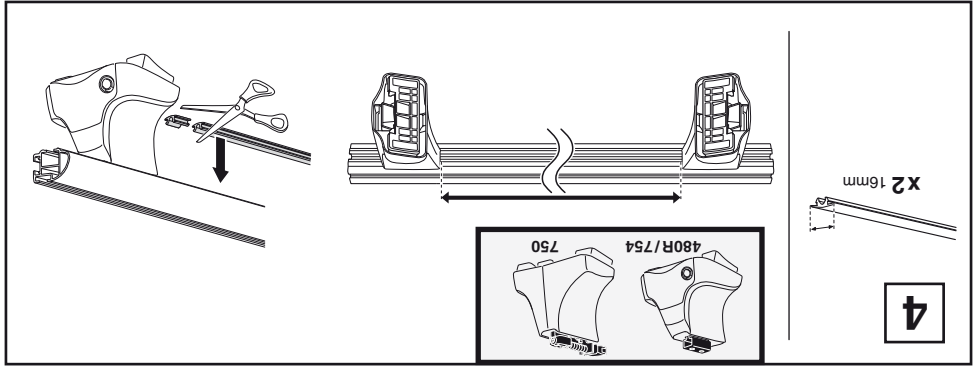

**1**

CITROËN Berlingo, 3-dr Van, 97-02, 03-08	35 1/8"	891 mm
CITROËN Xsara Picasso, 5-dr MPV, 00-03, 04-06	33 1/2"	851 mm
PEUGEOT Partner, 3/4-5-dr Van, 97-02, 03-08	35 1/8"	891 mm
PEUGEOT Ranch, 3/4-5-dr Van, 97-02, 03-08	35 1/8"	891 mm

Y inch  
mm

**2**

CITROËN Berlingo, 3-dr Van, 97-02, 03-08	34 7/8"	886 mm
CITROËN Xsara Picasso, 5-dr MPV, 00-03, 04-06	33 7/8"	861 mm
PEUGEOT Partner, 3/4-5-dr Van, 97-02, 03-08	34 7/8"	886 mm
PEUGEOT Ranch, 3/4-5-dr Van, 97-02, 03-08	34 7/8"	886 mm

X inch  
mm

**3**

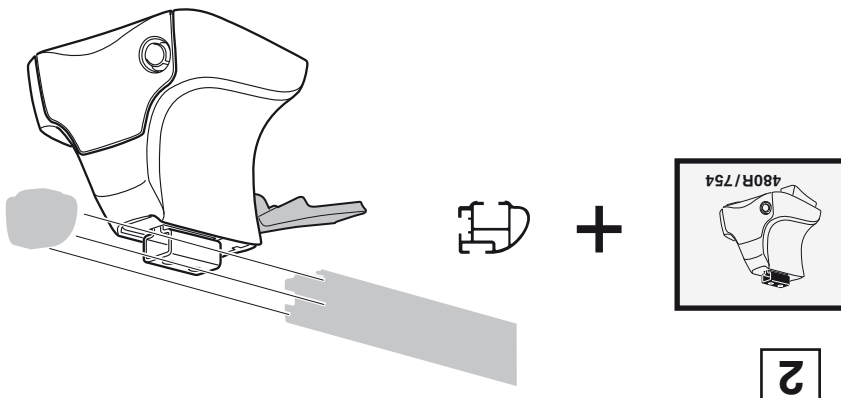
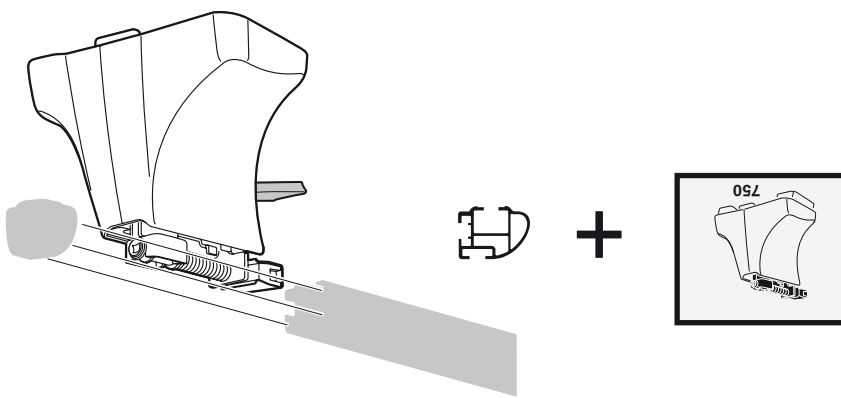

2

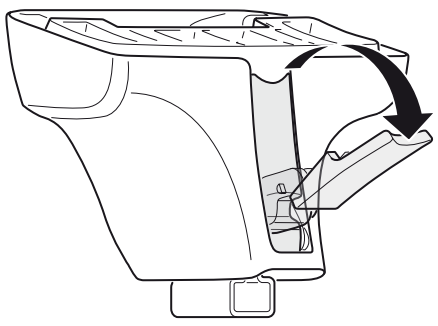

1

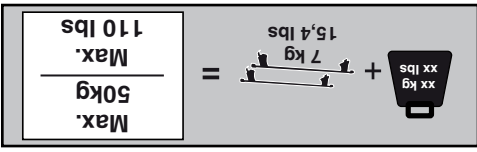
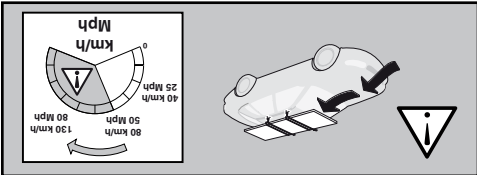
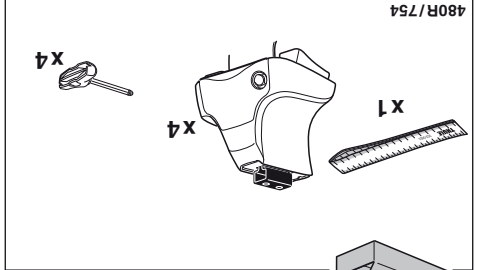
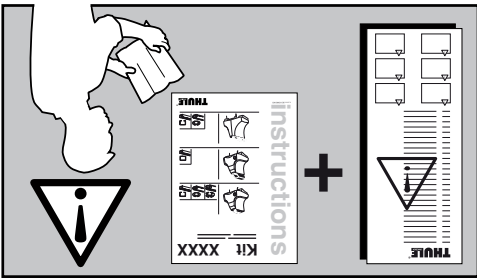
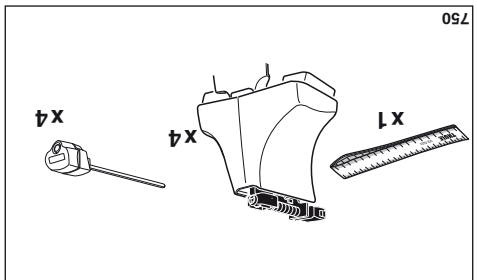
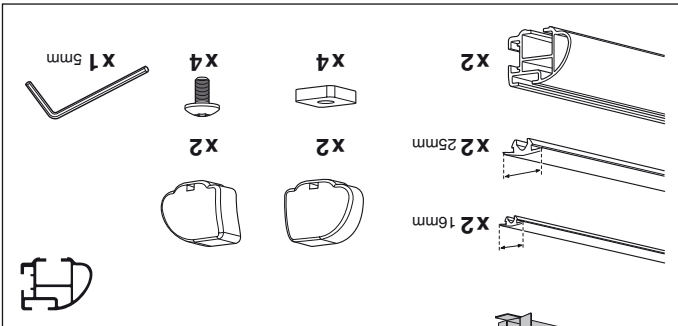
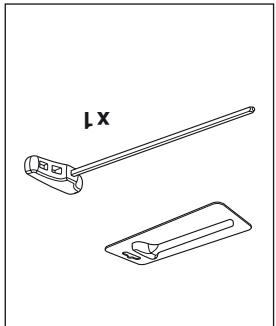
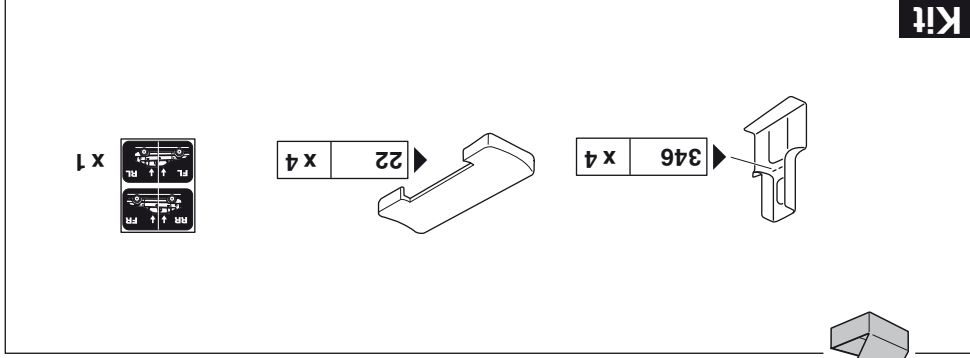

# instructions

© 2009/713 503-1184

ISO 11154-E

PROFESSIONAL

**THULE**  
SWEDEN<sup>®</sup>

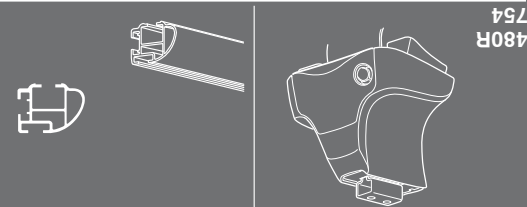
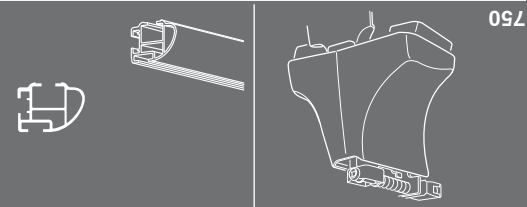

\* without sunroof

CITROËN Berlingo, 3-dr Van, 97-02, 03-08  
CITROËN Xsara Picasso, 5-dr MPV, 00-03, 04-06\*  
PEUGEOT Partner, 3/4/5-dr Van, 97-02, 03-08  
PEUGEOT Ranch, 3/4/5-dr Van, 97-02, 03-08

# Kit 1184