

# Kit 1292

**FORD Ranger**, 2-dr Single Cab, 98-02, 03-  
**FORD Ranger**, 2-dr Super Cab, \*98-  
**FORD Ranger**, 4-dr Double Cab, 98-02, 03-  
**FORD Ranger**, 4-dr Super Cab, 98-02, 03-  
**MAZDA B-Series**, 2-dr Single Cab, 98-  
**MAZDA B-Series**, 3-dr Extended Cab, \*98-  
**MAZDA B-Series**, 4-dr Double Cab, 98-  
**MAZDA B-Series**, 4-dr Extended Cab, \*98-  
**MAZDA BT-50**, 2-dr Single Cab, 07-  
**MAZDA BT-50**, 4-dr Crew Cab, 07-  
**MAZDA BT-50**, 4-dr Double Cab, 07-  
**MAZDA Freestyle**, 4-dr Maxi Cab, 03-

\*North America

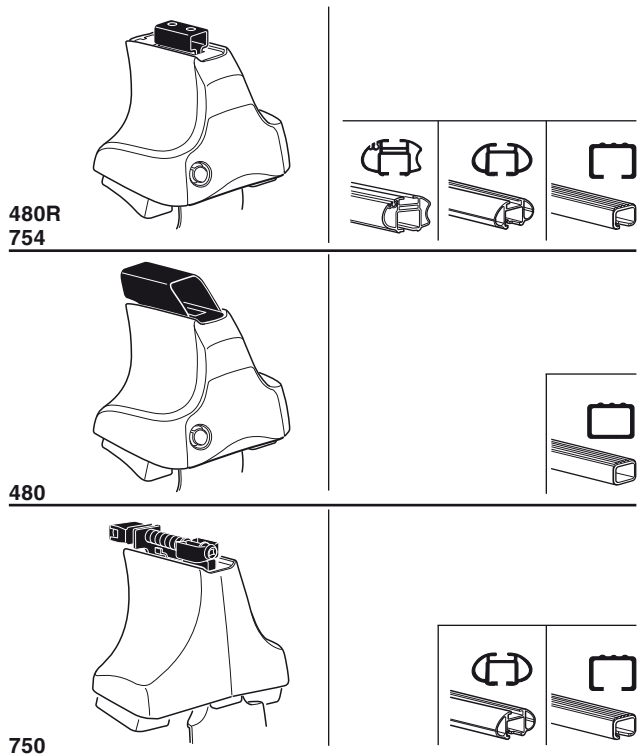

**Kit**

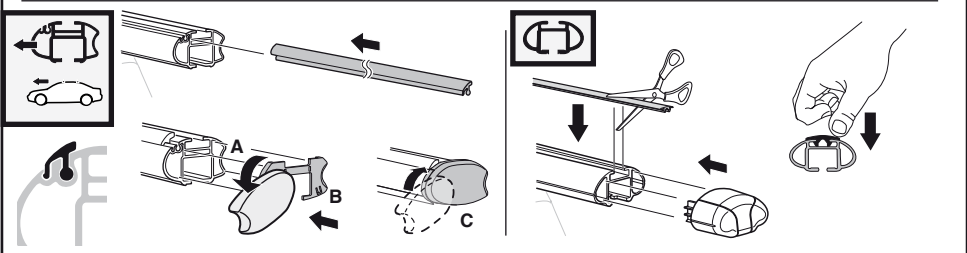
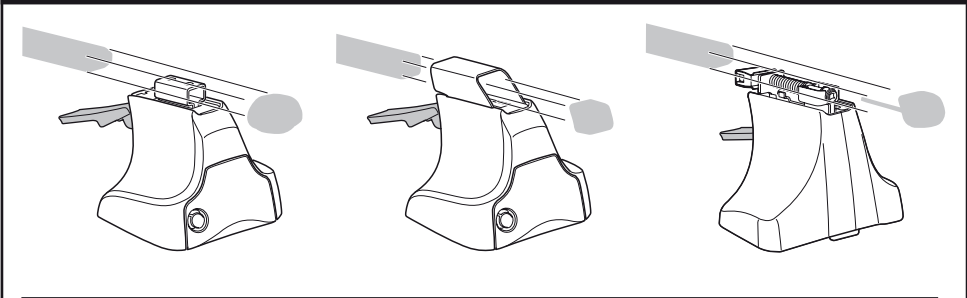

**3**

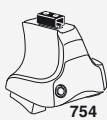

754

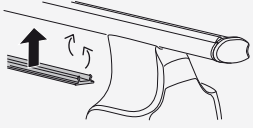

750

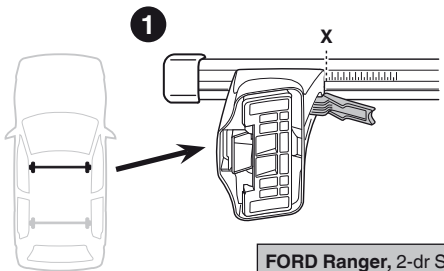

	X
<b>FORD Ranger, 2-dr Single Cab, 98-02, 03-</b>	<b>33</b>
<b>FORD Ranger, 2-dr Super Cab, *98-</b>	<b>33</b>
<b>FORD Ranger, 4-dr Double Cab, 98-02, 03-</b>	<b>32,5</b>
<b>FORD Ranger, 4-dr Super Cab, 98-02, 03-</b>	<b>32,5</b>
<b>MAZDA B-series, 2-dr Single Cab, 98-</b>	<b>33</b>
<b>MAZDA B-series, 3-dr Extended Cab, *98-</b>	<b>33</b>
<b>MAZDA B-series, 4-dr Double Cab, 98-</b>	<b>32,5</b>
<b>MAZDA B-series, 4-dr Extended Cab, *98-</b>	<b>32,5</b>
<b>MAZDA BT-50, 2-dr Single Cab, 07-</b>	<b>33,5</b>
<b>MAZDA BT-50, 4-dr Crew Cab, 07-</b>	<b>33,5</b>
<b>MAZDA BT-50, 4-dr Double Cab, 07-</b>	<b>33,5</b>
<b>MAZDA Freestyle, 4-dr Maxi Cab, 03-</b>	<b>32,5</b>

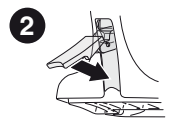
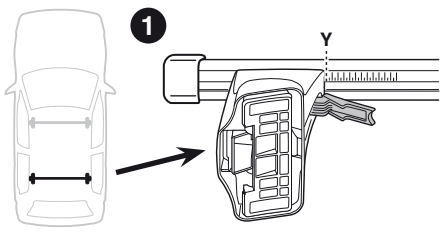

	Y
<b>FORD Ranger, 2-dr Single Cab, 98-02, 03-</b>	<b>-</b>
<b>FORD Ranger, 2-dr Super Cab, *98-</b>	<b>-</b>
<b>FORD Ranger, 4-dr Double Cab, 98-02, 03-</b>	<b>32,5</b>
<b>FORD Ranger, 4-dr Super Cab, 98-02, 03-</b>	<b>32,5</b>
<b>MAZDA B-series, 2-dr Single Cab, 98-</b>	<b>-</b>
<b>MAZDA B-series, 3-dr Extended Cab, *98-</b>	<b>-</b>
<b>MAZDA B-series, 4-dr Double Cab, 98-</b>	<b>32,5</b>
<b>MAZDA B-series, 4-dr Extended Cab, *98-</b>	<b>32,5</b>
<b>MAZDA BT-50, 2-dr Single Cab, 07-</b>	<b>-</b>
<b>MAZDA BT-50, 4-dr Crew Cab, 07-</b>	<b>32,5</b>
<b>MAZDA BT-50, 4-dr Double Cab, 07-</b>	<b>32,5</b>
<b>MAZDA Freestyle, 4-dr Maxi Cab, 03-</b>	<b>32,5</b>

**3**



480R



480

**1**

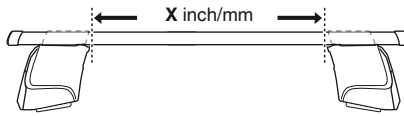

**2**

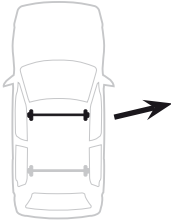

	X inch	X mm
<b>FORD Ranger, 2-dr Single Cab, 98-02, 03-</b>	<b>38 <sup>5</sup>/<sub>8</sub> "</b>	<b>981 mm</b>
<b>FORD Ranger, 2-dr Super Cab, *98-</b>	<b>38 <sup>5</sup>/<sub>8</sub> "</b>	<b>981 mm</b>
<b>FORD Ranger, 4-dr Double Cab, 98-02, 03-</b>	<b>38 <sup>3</sup>/<sub>8</sub> "</b>	<b>976 mm</b>
<b>FORD Ranger, 4-dr Super Cab, 98-02, 03-</b>	<b>38 <sup>3</sup>/<sub>8</sub> "</b>	<b>976 mm</b>
<b>MAZDA B-series, 2-dr Single Cab, 98-</b>	<b>38 <sup>5</sup>/<sub>8</sub> "</b>	<b>981 mm</b>
<b>MAZDA B-series, 3-dr Extended Cab, *98-</b>	<b>38 <sup>5</sup>/<sub>8</sub> "</b>	<b>981 mm</b>
<b>MAZDA B-series, 4-dr Double Cab, 98-</b>	<b>38 <sup>7</sup>/<sub>8</sub> "</b>	<b>986 mm</b>
<b>MAZDA B-series, 4-dr Extended Cab, *98-</b>	<b>38 <sup>7</sup>/<sub>8</sub> "</b>	<b>986 mm</b>
<b>MAZDA BT-50, 2-dr Single Cab, 07-</b>	<b>38 <sup>7</sup>/<sub>8</sub> "</b>	<b>986 mm</b>
<b>MAZDA BT-50, 4-dr Crew Cab, 07-</b>	<b>38 <sup>7</sup>/<sub>8</sub> "</b>	<b>986 mm</b>
<b>MAZDA BT-50, 4-dr Double Cab, 07-</b>	<b>38 <sup>7</sup>/<sub>8</sub> "</b>	<b>986 mm</b>
<b>MAZDA Freestyle, 4-dr Maxi Cab, 03-</b>	<b>38 <sup>3</sup>/<sub>8</sub> "</b>	<b>976 mm</b>

**1**

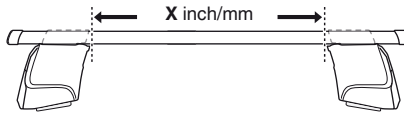

**2**

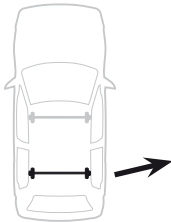

	Y inch	Y mm
<b>FORD Ranger, 2-dr Single Cab, 98-02, 03-</b>	-	-
<b>FORD Ranger, 2-dr Super Cab, *98-</b>	-	-
<b>FORD Ranger, 4-dr Double Cab, 98-02, 03-</b>	<b>38 <sup>3</sup>/<sub>8</sub> "</b>	<b>976 mm</b>
<b>FORD Ranger, 4-dr Super Cab, 98-02, 03-</b>	<b>38 <sup>3</sup>/<sub>8</sub> "</b>	<b>976 mm</b>
<b>MAZDA B-series, 2-dr Single Cab, 98-</b>	-	-
<b>MAZDA B-series, 3-dr Extended Cab, *98-</b>	-	-
<b>MAZDA B-series, 4-dr Double Cab, 98-</b>	<b>38 <sup>3</sup>/<sub>8</sub> "</b>	<b>976 mm</b>
<b>MAZDA B-series, 4-dr Extended Cab, *98-</b>	<b>38 <sup>3</sup>/<sub>8</sub> "</b>	<b>976 mm</b>
<b>MAZDA BT-50, 2-dr Single Cab, 07-</b>	-	-
<b>MAZDA BT-50, 4-dr Crew Cab, 07-</b>	<b>38 <sup>3</sup>/<sub>8</sub> "</b>	<b>976 mm</b>
<b>MAZDA BT-50, 4-dr Double Cab, 07-</b>	<b>38 <sup>3</sup>/<sub>8</sub> "</b>	<b>976 mm</b>
<b>MAZDA Freestyle, 4-dr Maxi Cab, 03-</b>	<b>38 <sup>3</sup>/<sub>8</sub> "</b>	<b>976 mm</b>

**4**

**FORD Ranger**, 2-dr Single Cab, 98-02, 03-  
**FORD Ranger**, 2-dr Super Cab, \*98-  
**MAZDA B-series**, 2-dr Single Cab, 98-  
**MAZDA B-series**, 3-dr Extended Cab, \*98-  
**MAZDA BT-50**, 2-dr Single Cab, 07-

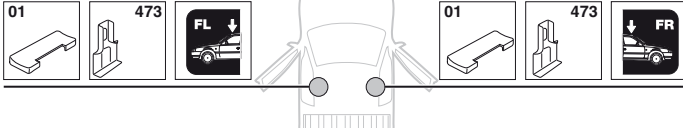

**FORD Ranger**, 4-dr Double Cab, 98-02, 03-  
**FORD Ranger**, 4-dr Super Cab, 98-02, 03-  
**MAZDA B-series**, 4-dr Double Cab, 98-  
**MAZDA B-series**, 4-dr Extended Cab, \*98-  
**MAZDA BT-50**, 4-dr Crew Cab, 07-  
**MAZDA BT-50**, 4-dr Double Cab, 07-  
**MAZDA Freestyle**, 4-dr Maxi Cab, 03-

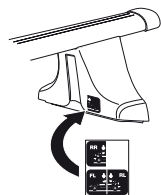
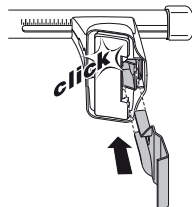
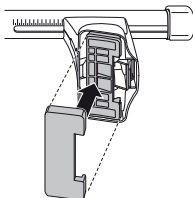
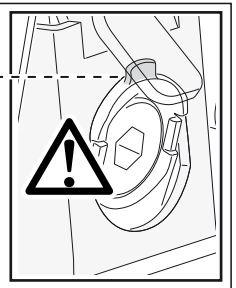
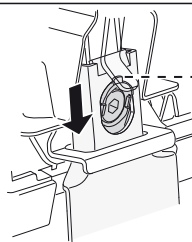
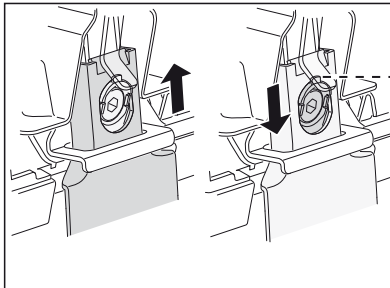
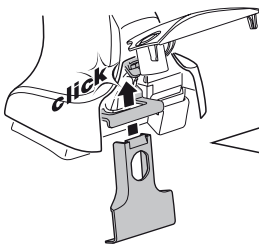
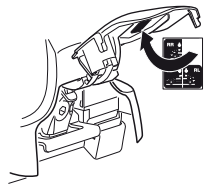
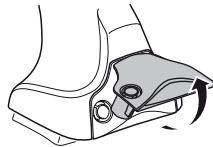
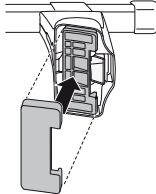
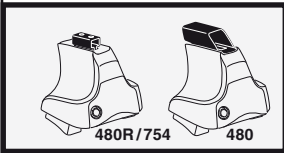
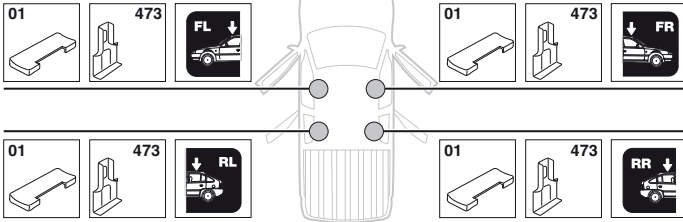

5

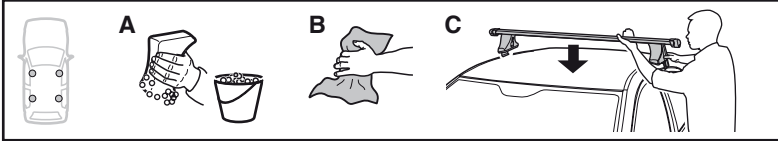

	X mm	Y mm	X inch	Y inch
<b>FORD Ranger, 2-dr Single Cab, 98-02, 03-</b>	320 mm	-	12 <sup>5</sup> / <sub>8</sub> "	-
<b>FORD Ranger, 2-dr Super Cab, *98-</b>	320 mm	-	12 <sup>5</sup> / <sub>8</sub> "	-
<b>MAZDA B-series, 2-dr Single Cab, 98-</b>	320 mm	-	12 <sup>5</sup> / <sub>8</sub> "	-
<b>MAZDA B-series, 3-dr Extended Cab, *98-</b>	320 mm	-	12 <sup>5</sup> / <sub>8</sub> "	-
<b>MAZDA BT-50, 2-dr Single Cab, 07-</b>	320 mm	-	12 <sup>5</sup> / <sub>8</sub> "	-

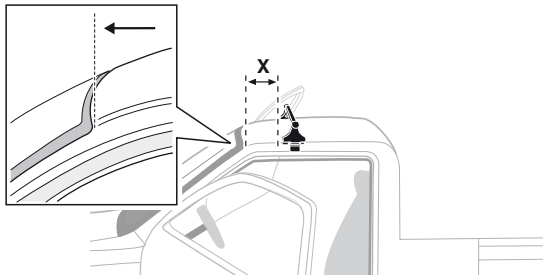

	X mm	Y mm	X inch	Y inch
<b>FORD Ranger, 4-dr Double Cab, 98-02, 03-</b>	320 mm	750 mm	12 <sup>5</sup> / <sub>8</sub> "	29 <sup>1</sup> / <sub>2</sub> "
<b>FORD Ranger, 4-dr Super Cab, 98-02, 03-</b>	320 mm	750 mm	12 <sup>5</sup> / <sub>8</sub> "	29 <sup>1</sup> / <sub>2</sub> "
<b>MAZDA B-series, 4-dr Double Cab, 98-</b>	320 mm	750 mm	12 <sup>5</sup> / <sub>8</sub> "	29 <sup>1</sup> / <sub>2</sub> "
<b>MAZDA B-series, 4-dr Extended Cab, *98-</b>	320 mm	750 mm	12 <sup>5</sup> / <sub>8</sub> "	29 <sup>1</sup> / <sub>2</sub> "
<b>MAZDA BT-50, 4-dr Crew Cab, 07-</b>	320 mm	750 mm	12 <sup>5</sup> / <sub>8</sub> "	29 <sup>1</sup> / <sub>2</sub> "
<b>MAZDA BT-50, 4-dr Double Cab, 07-</b>	320 mm	750 mm	12 <sup>5</sup> / <sub>8</sub> "	29 <sup>1</sup> / <sub>2</sub> "
<b>MAZDA Freestyle, 4-dr Maxi Cab, 03-</b>	320 mm	750 mm	12 <sup>5</sup> / <sub>8</sub> "	29 <sup>1</sup> / <sub>2</sub> "

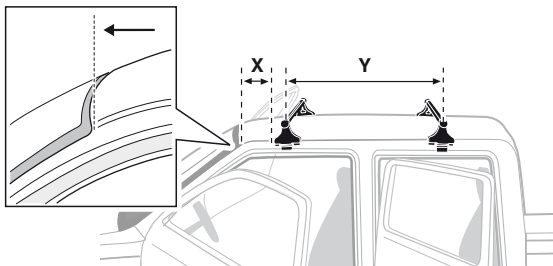

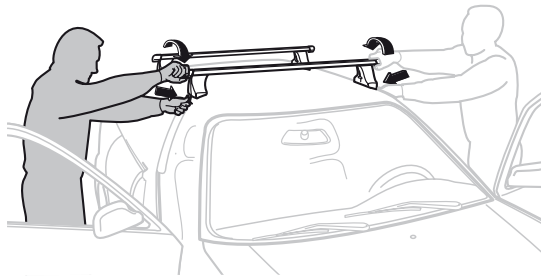
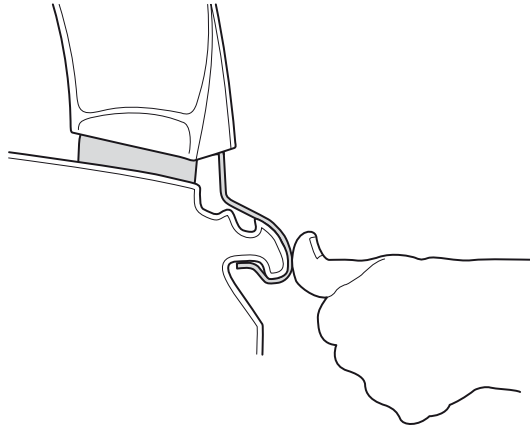
**6****GB/US** Tighten alternately**D** Die Schrauben  
abwechselnd anziehen**F** Serrer alternativement  
chaque côté**NL** Afwisselend aan de  
linker- en de rechterkant  
aandraaien**I** Alternare il serraggio delle  
viti**E** Serrare alternativamente**PT** Aperte alternadamente**S** Dra åt växelvis**FIN** Kierrä vuorotellen**EST** Pinguldage vaheldumisi**LAT** Pievelciet pamišus**LIT** Užsukinėkite pakaitomis**PL** Śruby dokręcaj  
naprzemiennie**RU** Затягивайте  
попеременно**CZ** Pokręťta багаžnika  
dokręcaj dokręcaj  
naprzemiennie.**SK** Doťahujte striedavo**SLO** Privijajte izmenično.**HR** Naizmjenično zategnite**HU** Egymástól függetlenül  
szorítandó**GR** Σφίγγετε εναλλάξ**TR** Dönüşümlü sıkın**中文** 交替拧紧**한국어** 번갈아 가며 조이십시오.**日本語** 交互に締め付けてください。**ไทย** ชันในแบบสลับ



6



480R/754



480

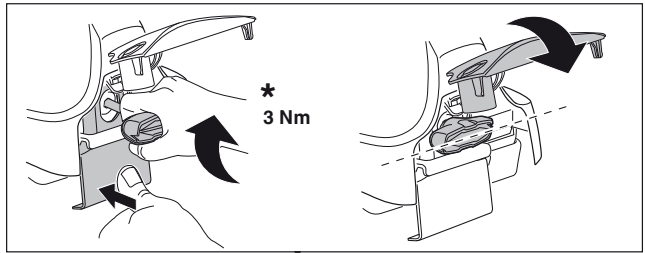
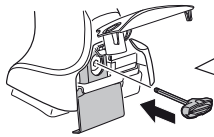

\*  
3 Nm

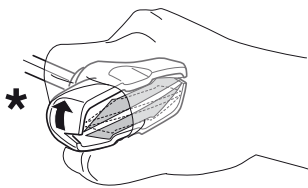

\*

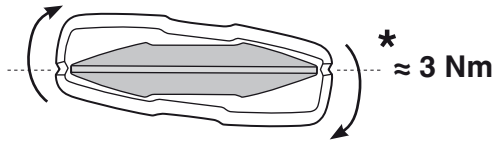

\*  
≈ 3 Nm

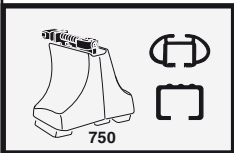
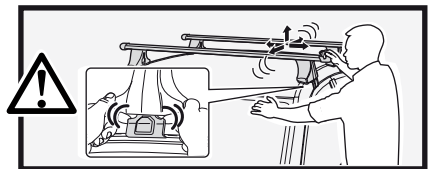

750

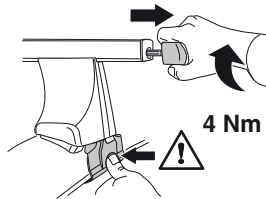

4 Nm

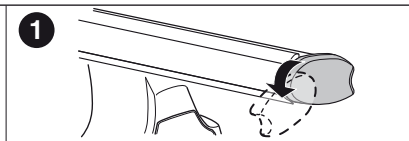
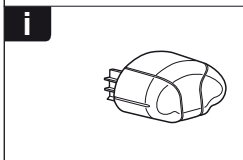
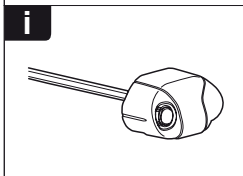
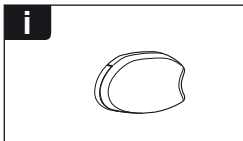
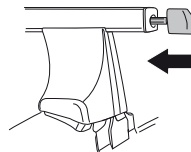

1

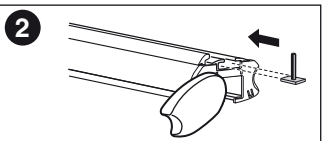

2

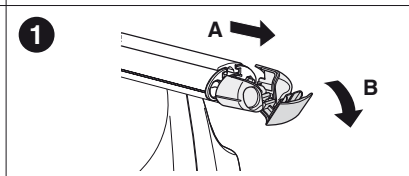

1

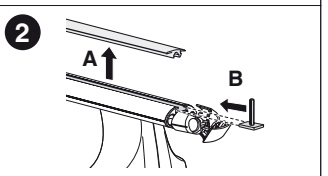

2

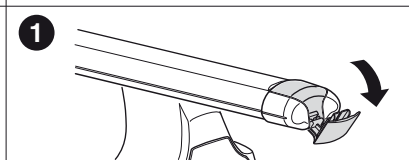

1

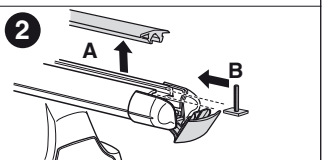

2

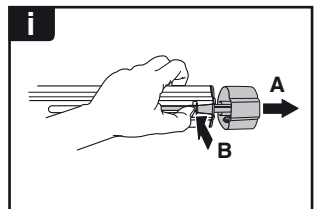
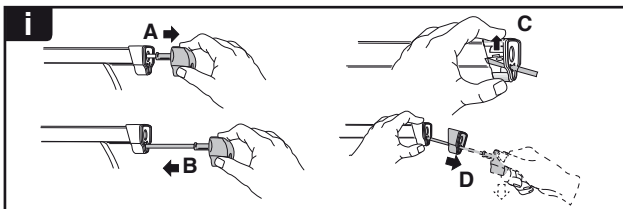
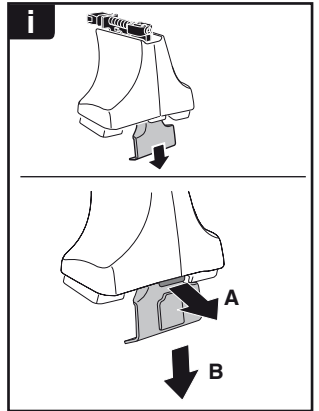
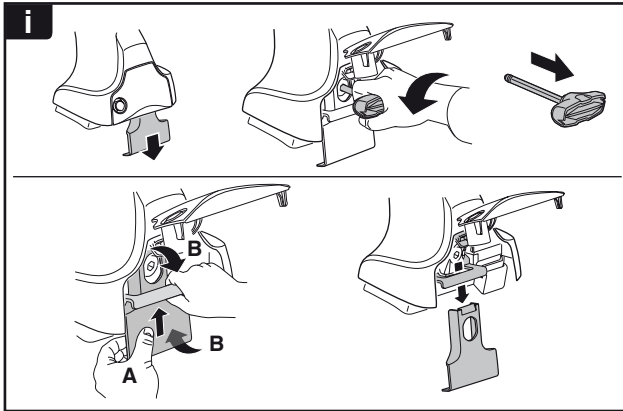
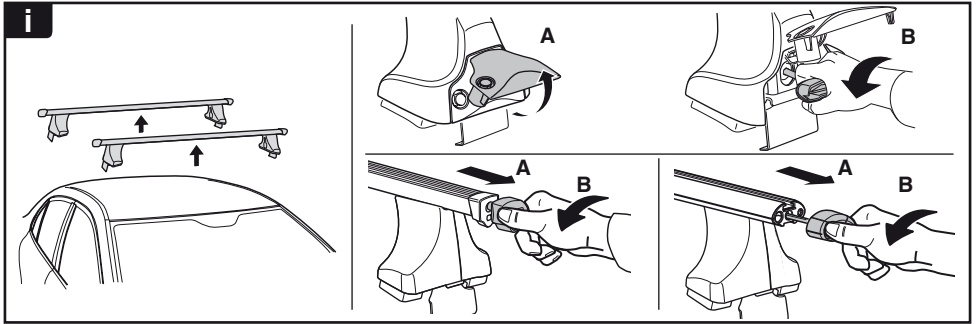

**THULE**  
SWEDEN  
**ONE  
KEY  
SYSTEM**

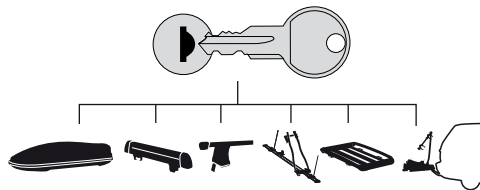

- 544 (x4)
- 596 (x6)
- 588 (x8)
- NA 510 (x10)
- EUR 452 (x12)
- ASIA

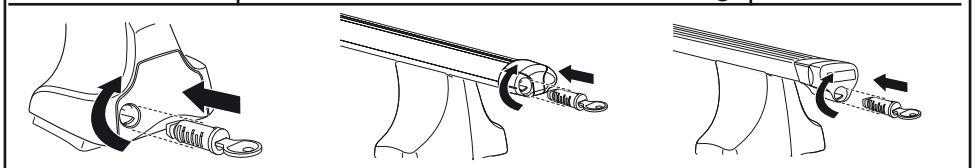

WW ▶ Thule Sweden AB, Box 69, 330 33 Hillerstorp, SWEDEN  
NA ▶ Thule Inc., 42 Silvermine Road, Seymour, Connecticut 06483, USA

info@thule.com  
customer.service@thule.com

www.thule.com



 [www.thuleprofessional.com](http://www.thuleprofessional.com)

 [info@thule.com](mailto:info@thule.com)  
[customer.service@thule.com](mailto:customer.service@thule.com)

 Thule Inc., 42 Silvermine Road, Seymour, Connecticut 06483, USA  
Thule Sweden AB, Box 69, 330 33 Hillerstorp, SWEDEN

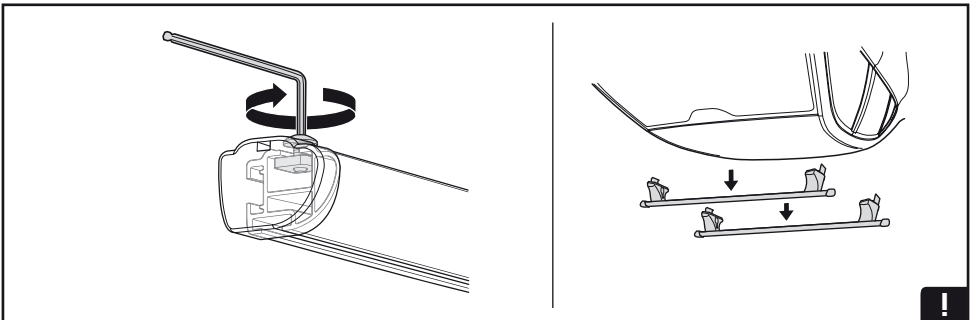
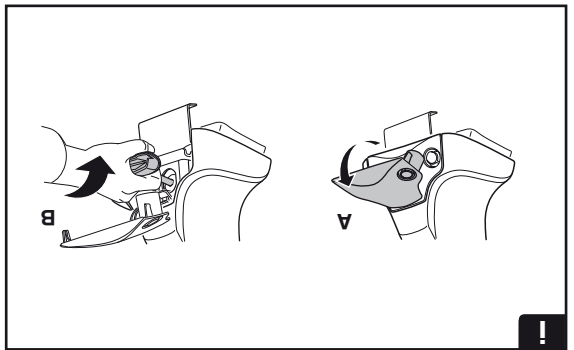
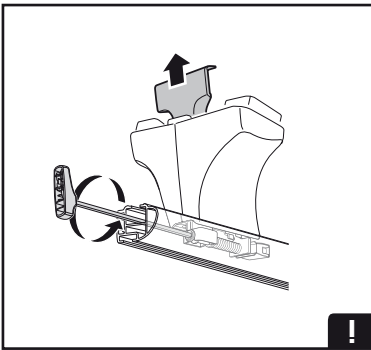
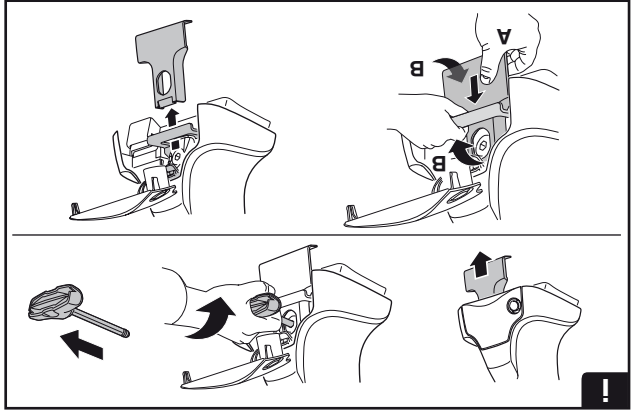
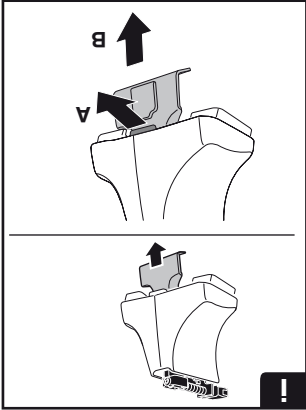

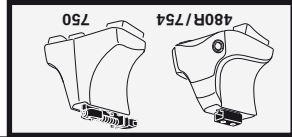
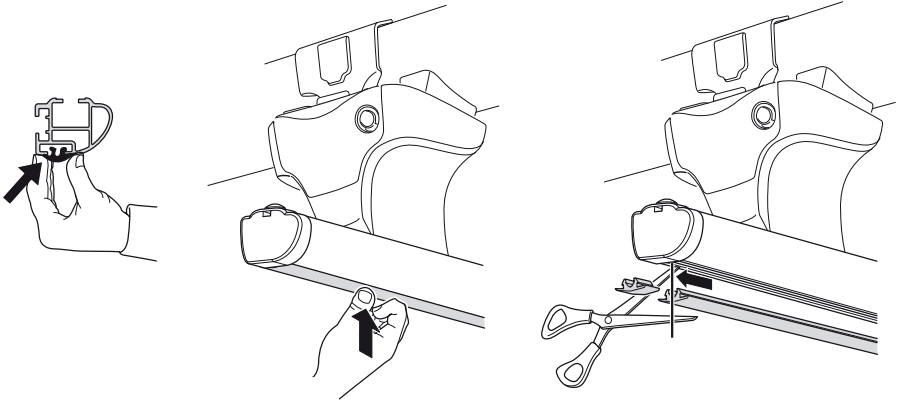

9

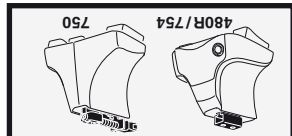
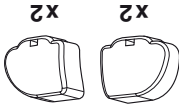
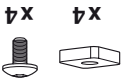
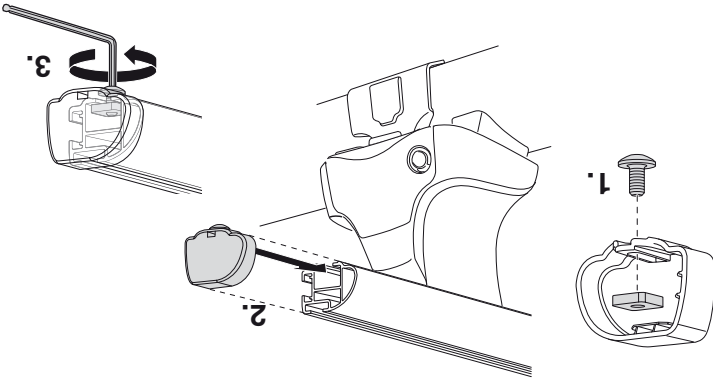

8

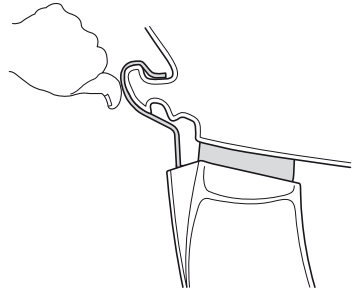
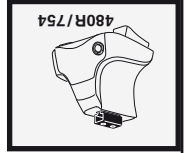
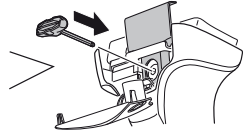
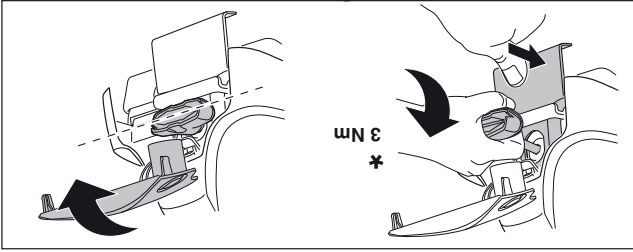
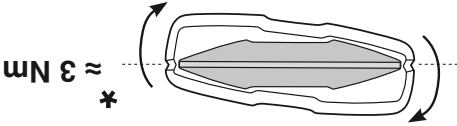
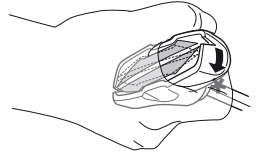
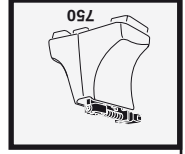
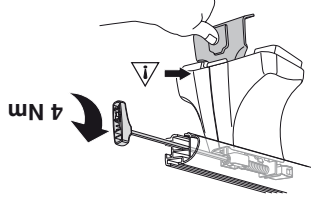
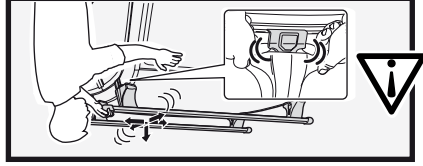

GB/US Tighten alternately  
D Die Schrauben abwechselnd  
anziehen  
F Serrer alternativement chaque côté  
NL Afwisselend aan de linker- en de  
rechterkant aandraaien  
I Alternare il serraggio delle viti  
E Serrare alternativamente  
PT Aperte alternadamente  
S Dra åt växelvis  
FIN Kierrä vuorotellen  
EST Pügilidage vaheldumisi  
LAT Pīvēciņiet pārtīsus  
LIT Užskūnėkite pakaitomis  
PL Słubę dokręcaj naprzemiennie  
RU Затягивайте попеременно

CZ Pokrétla bagazníka dokręcaj  
SK Dotiahľte striedavo  
SLO Privijajte izmenično.  
HR Najmanje jedno zategnite  
HU Egymástól fuggően  
szorítandó  
GR Ζφύγεται εναλλάξ  
TR Donuşumlu sıkın  
中文 交替拧紧  
한국어 평갈이 가며 조이십시오.  
日本語 交互に締め付けてください。  
Українська

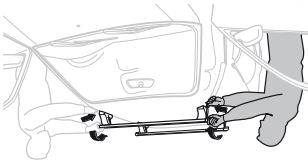

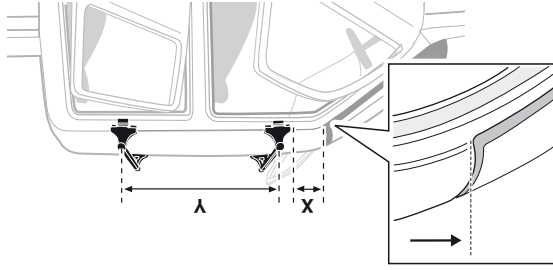

MAZDA Freestyle, 4-dr Maxi Cab, 03-	320 mm	750 mm	12 5/8"	29 1/2"
MAZDA BT-50, 4-dr Double Cab, 07-	320 mm	750 mm	12 5/8"	29 1/2"
MAZDA BT-50, 4-dr Crew Cab, 07-	320 mm	750 mm	12 5/8"	29 1/2"
MAZDA B-series, 4-dr Extended Cab, *98-	320 mm	750 mm	12 5/8"	29 1/2"
MAZDA B-series, 4-dr Double Cab, 98-	320 mm	750 mm	12 5/8"	29 1/2"
FORD Ranger, 4-dr Super Cab, 98-02, 03-	320 mm	750 mm	12 5/8"	29 1/2"
FORD Ranger, 4-dr Double Cab, 98-02, 03-	320 mm	750 mm	12 5/8"	29 1/2"

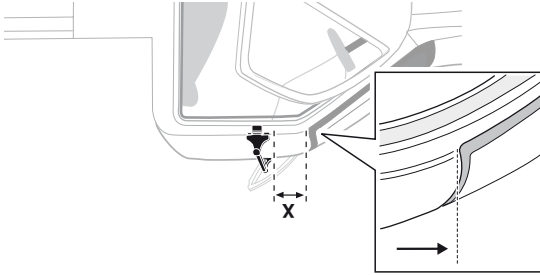

MAZDA BT-50, 2-dr Single Cab, 07-	320 mm	Y mm	12 5/8"	X inch
MAZDA B-series, 3-dr Extended Cab, *98-	320 mm	Y mm	12 5/8"	X inch
MAZDA B-series, 2-dr Single Cab, 98-	320 mm	Y mm	12 5/8"	X inch
FORD Ranger, 2-dr Super Cab, *98-	320 mm	Y mm	12 5/8"	X inch
FORD Ranger, 2-dr Single Cab, 98-02, 03-	320 mm	Y mm	12 5/8"	X inch

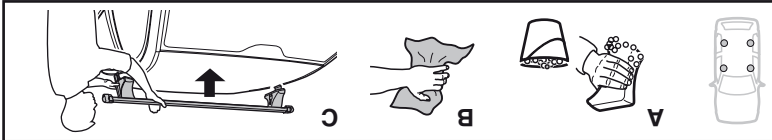

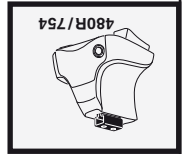
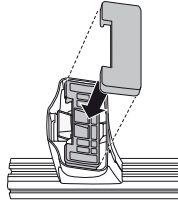
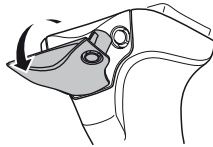
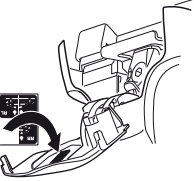
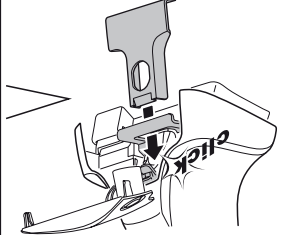
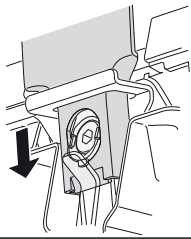
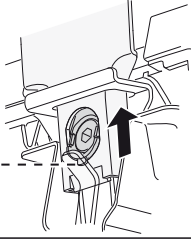
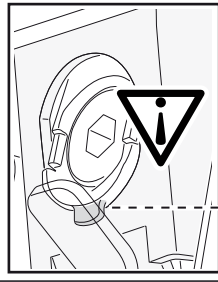
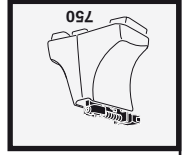
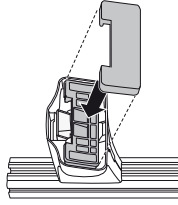
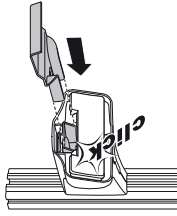
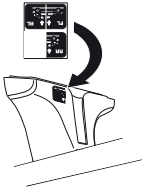

**FORD Ranger**, 4-dr Double Cab, 98-02, 03-  
**FORD Ranger**, 4-dr Super Cab, 98-02, 03-  
**MAZDA B-series**, 4-dr Double Cab, 98-  
**MAZDA B-series**, 4-dr Extended Cab, \*98-  
**MAZDA BT-50**, 4-dr Crew Cab, 07-  
**MAZDA BT-50**, 4-dr Double Cab, 07-  
**MAZDA Freestyle**, 4-dr Maxi Cab, 03-



**FORD Ranger**, 2-dr Single Cab, 98-02, 03-  
**FORD Ranger**, 2-dr Super Cab, \*98-  
**MAZDA B-series**, 2-dr Single Cab, 98-  
**MAZDA B-series**, 3-dr Extended Cab, \*98-  
**MAZDA BT-50**, 2-dr Single Cab, 07-



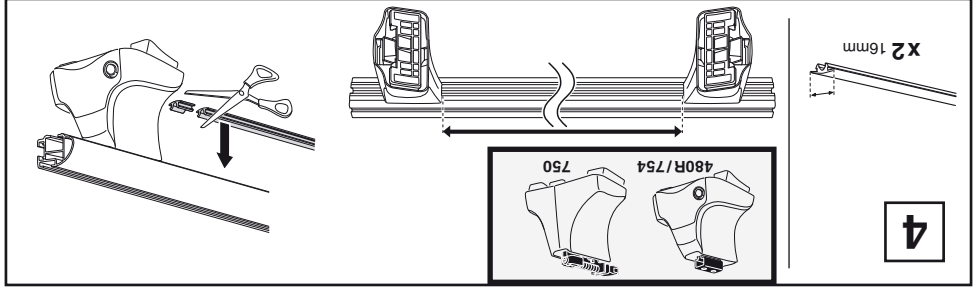

FORD Ranger, 2-dr Single Cab, 98-02, 03	38 3/8"	976 mm
FORD Ranger, 2-dr Super Cab, *98-	—	—
FORD Ranger, 4-dr Double Cab, 98-02, 03-	38 3/8"	976 mm
FORD Ranger, 4-dr Super Cab, 98-02, 03-	38 3/8"	976 mm
MAZDA B-series, 2-dr Single Cab, 98-	—	—
MAZDA B-series, 3-dr Extended Cab, *98-	—	—
MAZDA B-series, 4-dr Double Cab, 98-	38 3/8"	976 mm
MAZDA B-series, 4-dr Extended Cab, *98-	38 3/8"	976 mm
MAZDA BT-50, 2-dr Single Cab, 07-	—	—
MAZDA BT-50, 4-dr Crew Cab, 07-	38 3/8"	976 mm
MAZDA BT-50, 4-dr Double Cab, 07-	38 3/8"	976 mm
MAZDA Freestyle, 4-dr Maxi Cab, 03-	38 3/8"	976 mm

Y inch      Y mm

FORD Ranger, 2-dr Single Cab, 98-02, 03-	38 3/8"	981 mm
FORD Ranger, 2-dr Super Cab, *98-	38 3/8"	981 mm
FORD Ranger, 4-dr Double Cab, 98-02, 03-	38 3/8"	976 mm
FORD Ranger, 4-dr Super Cab, 98-02, 03-	38 3/8"	976 mm
MAZDA B-series, 2-dr Single Cab, 98-	38 3/8"	981 mm
MAZDA B-series, 3-dr Extended Cab, *98-	38 3/8"	981 mm
MAZDA B-series, 4-dr Double Cab, 98-	38 7/8"	986 mm
MAZDA B-series, 4-dr Extended Cab, *98-	38 7/8"	986 mm
MAZDA BT-50, 2-dr Single Cab, 07-	38 7/8"	986 mm
MAZDA BT-50, 4-dr Crew Cab, 07-	38 7/8"	986 mm
MAZDA BT-50, 4-dr Double Cab, 07-	38 7/8"	986 mm
MAZDA Freestyle, 4-dr Maxi Cab, 03-	38 3/8"	976 mm

X inch      X mm

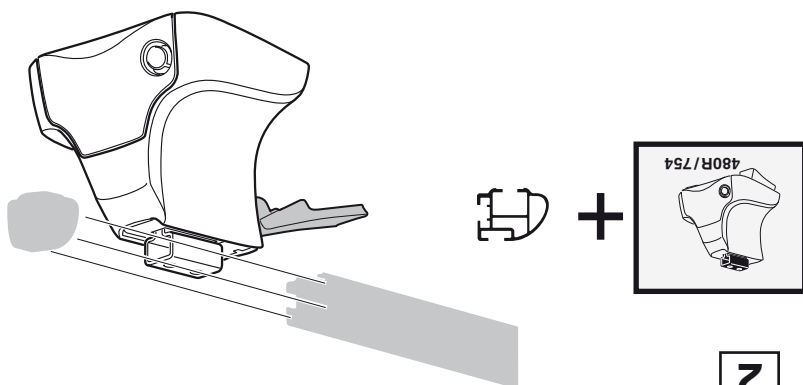
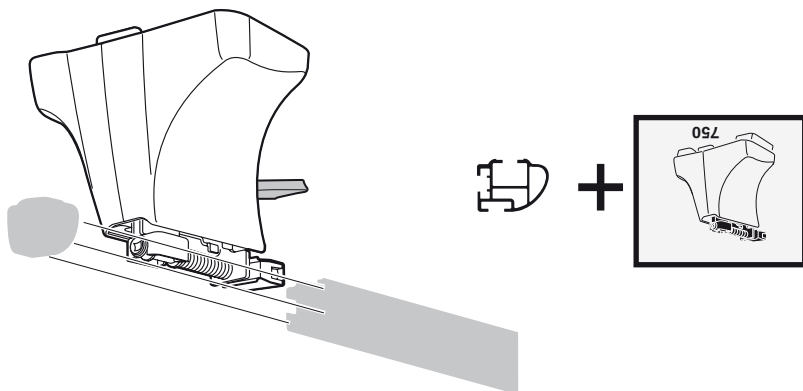

2

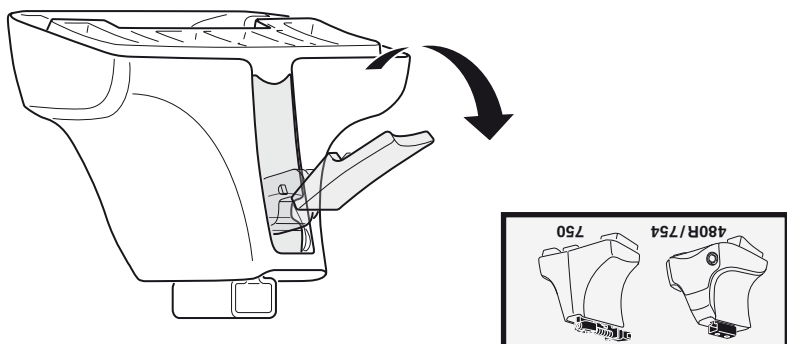

1

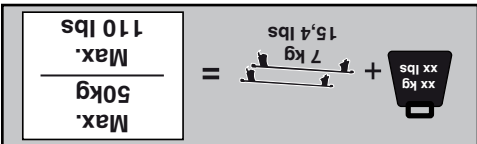
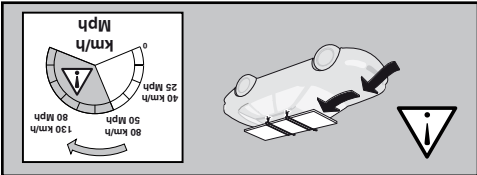
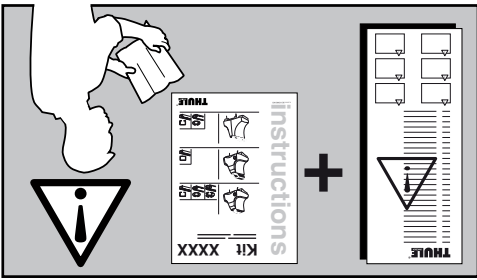
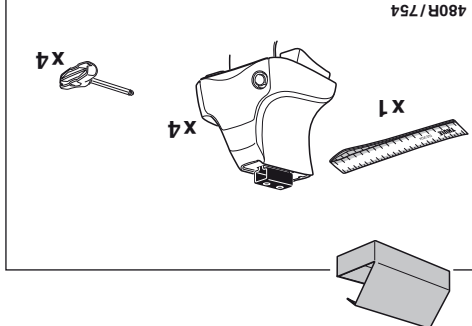
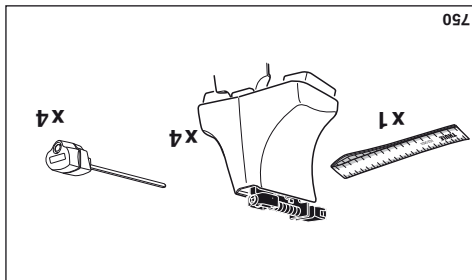
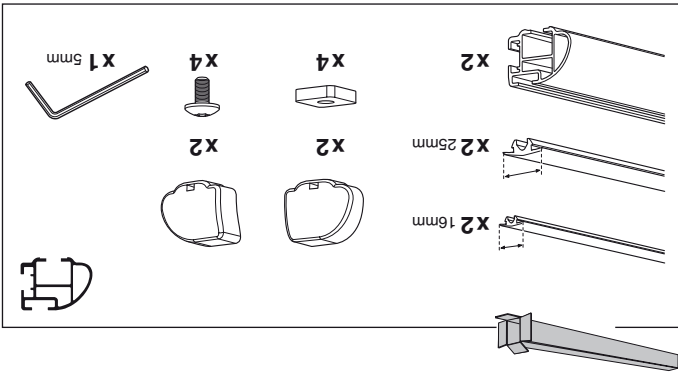
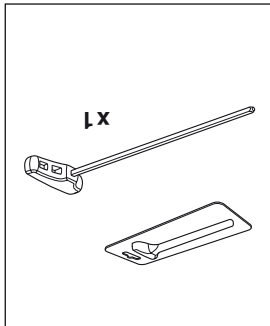
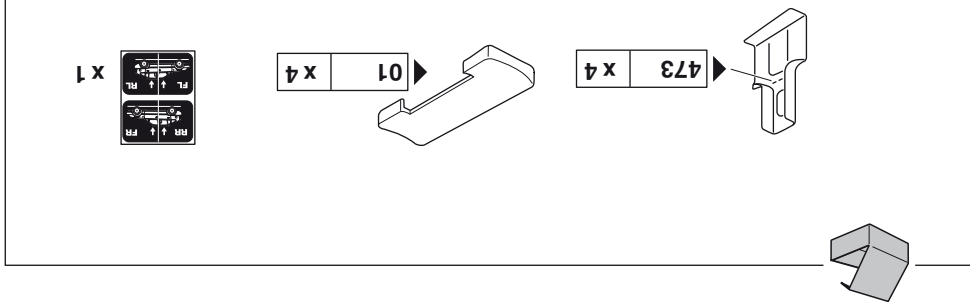

# instructions

© 20091109 503-1292-02

# Kit 1292

FORD Ranger, 2-dr Single Cab, 98-02, 03-  
FORD Ranger, 2-dr Super Cab, \*98-  
FORD Ranger, 4-dr Double Cab, 98-02, 03-  
FORD Ranger, 4-dr Super Cab, 98-02, 03-  
MAZDA B-series, 2-dr Single Cab, 98-  
MAZDA B-series, 3-dr Extended Cab, \*98-  
MAZDA B-series, 4-dr Double Cab, 98-  
MAZDA B-series, 4-dr Extended Cab, \*98-  
MAZDA BT-50, 2-dr Single Cab, 07-  
MAZDA BT-50, 4-dr Crew Cab, 07-  
MAZDA BT-50, 4-dr Double Cab, 07-  
MAZDA Freestyle, 4-dr Maxi Cab, 03-  
\*North America

480R  
754

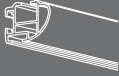
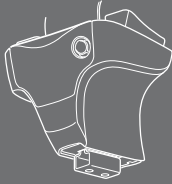

750

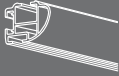
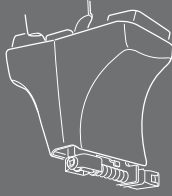

ISO 11154-E

THULE  
SWEDEN  
®

PROFESSIONAL