

Kit 1461

- CHEVROLET Colorado**, 4-dr Double Cab, 04–
- CHEVROLET Colorado**, 4-dr Extended Cab, 04–
- CHEVROLET Colorado**, 4-dr Crew Cab, *04–
- CHEVROLET Colorado**, 4-dr Extra Cab, *04–
- GMC Canyon**, 4-dr Crew Cab, *04–
- GMC Canyon**, 4-dr Extra Cab, *04–
- GREAT WALL V240**, 4-dr Double Cab, 09–
- GREAT WALL Steed**, 4-dr Double Cab, 09–
- GREAT WALL Wingle**, 4-dr Double Cab, 06–
- ISUZU D-max**, 4-dr Double Cab, 02–
- ISUZU D-max**, 4-dr Extended Cab, 02–
- ISUZU I-280/I-290**, 4-dr Crew Cab, *06-09
- ISUZU I-350/I-370**, 4-dr Extra Cab, *06-09

*North America

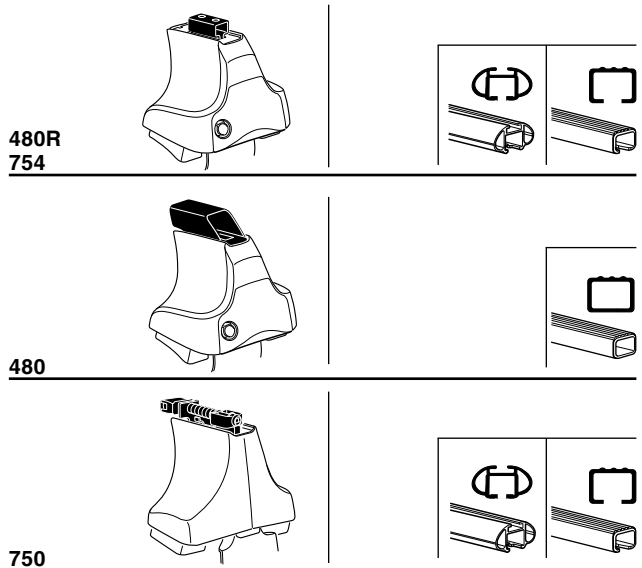

THULE®
SWEDEN

Kit

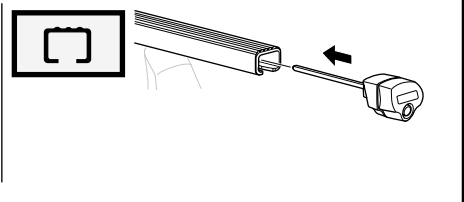
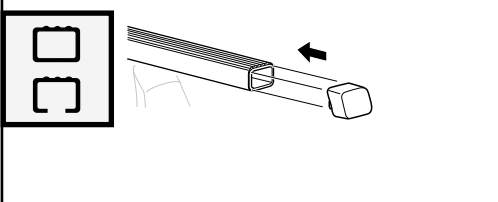
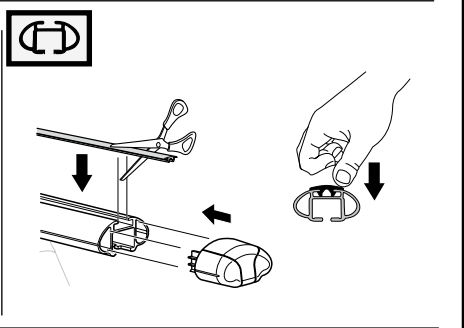
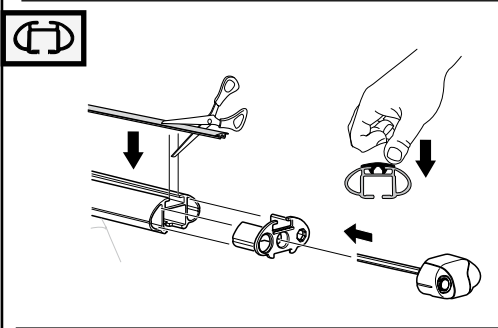
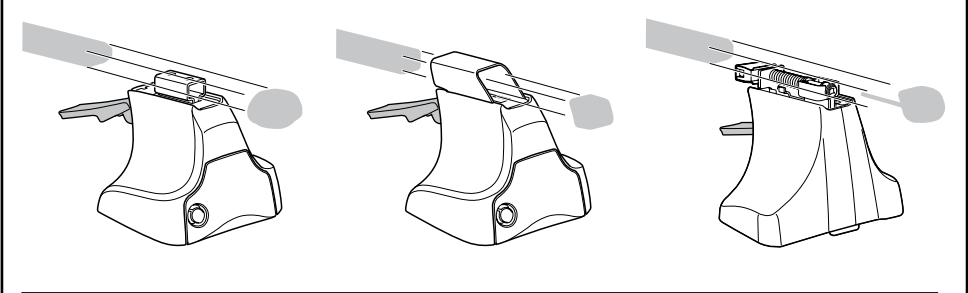
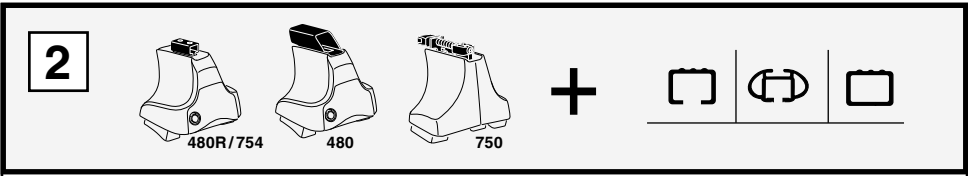
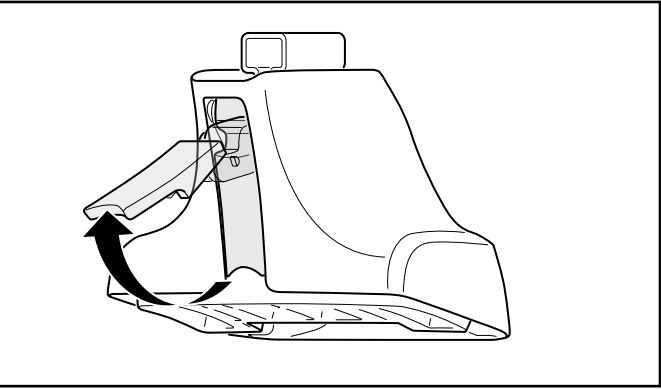
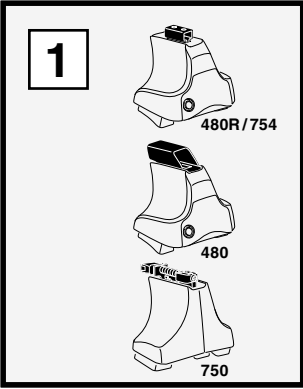

3

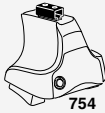

754



750



1

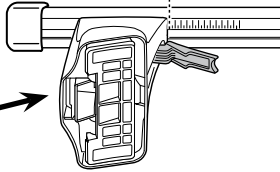
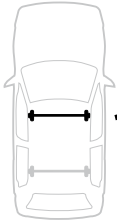

2

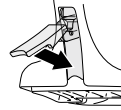

X

CHEVROLET Colorado , 4-dr Double Cab, 04–	34
CHEVROLET Colorado , 4-dr Extended Cab, 04–	34
CHEVROLET Colorado , 4-dr Crew Cab, *04–	34
CHEVROLET Colorado , 4-dr Extra Cab, *04–	34
GMC Canyon , 4-dr Crew Cab, *04–	34
GMC Canyon , 4-dr Extra Cab, *04–	34
GREAT WALL V240 , 4-dr Double Cab, 09–	34
GREAT WALL Steed , 4-dr Double Cab, 09–	34
GREAT WALL Wingle , 4-dr Double Cab, 06–	34
ISUZU D-max , 4-dr Double Cab, 02–	34
ISUZU D-max , 4-dr Extended Cab, 02–	34
ISUZU I-280/I-290 , 4-dr Crew Cab, *06-09	34
ISUZU I-350/I-370 , 4-dr Extra Cab, *06-09	34

1

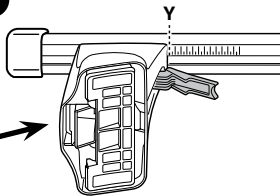

2

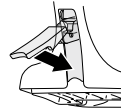

Y

CHEVROLET Colorado , 4-dr Double Cab, 04–	32
CHEVROLET Colorado , 4-dr Extended Cab, 04–	32
CHEVROLET Colorado , 4-dr Crew Cab, *04–	32
CHEVROLET Colorado , 4-dr Extra Cab, *04–	32
GMC Canyon , 4-dr Crew Cab, *04–	32
GMC Canyon , 4-dr Extra Cab, *04–	32
GREAT WALL V240 , 4-dr Double Cab, 09–	32
GREAT WALL Steed , 4-dr Double Cab, 09–	32
GREAT WALL Wingle , 4-dr Double Cab, 06–	32
ISUZU D-max , 4-dr Double Cab, 02–	32
ISUZU D-max , 4-dr Extended Cab, 02–	32
ISUZU I-280/I-290 , 4-dr Crew Cab, *06-09	32
ISUZU I-350/I-370 , 4-dr Extra Cab, *06-09	32

3



480



480R

1

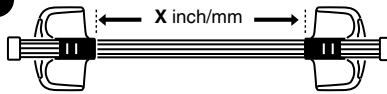

2

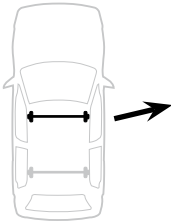
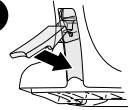

	X inch	X mm
CHEVROLET Colorado, 4-dr Double Cab, 04-	39"	991 mm
CHEVROLET Colorado, 4-dr Extended Cab, 04-	39"	991 mm
CHEVROLET Colorado, 4-dr Crew Cab, *04-	39"	991 mm
CHEVROLET Colorado, 4-dr Extra Cab, *04-	39"	991 mm
GMC Canyon, 4-dr Crew Cab, *04-	39"	991 mm
GMC Canyon, 4-dr Extra Cab, *04-	39"	991 mm
GREAT WALL V240, 4-dr Double Cab, 09-	39"	991 mm
GREAT WALL Steed, 4-dr Double Cab, 09-	39"	991 mm
GREAT WALL Wingle, 4-dr Double Cab, 06-	39"	991 mm
ISUZU D-max, 4-dr Double Cab, 02-	39"	991 mm
ISUZU D-max, 4-dr Extended Cab, 02-	39"	991 mm
ISUZU I-280/I-290, 4-dr Crew Cab, *06-09	39"	991 mm
ISUZU I-350/I-370, 4-dr Extra Cab, *06-09	39"	991 mm

1

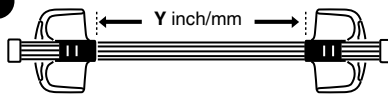

2

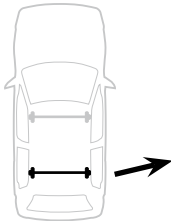
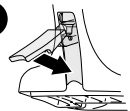

	Y inch	Y mm
CHEVROLET Colorado, 4-dr Double Cab, 04-	38 1/4"	971 mm
CHEVROLET Colorado, 4-dr Extended Cab, 04-	38 1/4"	971 mm
CHEVROLET Colorado, 4-dr Crew Cab, *04-	38 1/4"	971 mm
CHEVROLET Colorado, 4-dr Extra Cab, *04-	38 1/4"	971 mm
GMC Canyon, 4-dr Crew Cab, *04-	38 1/4"	971 mm
GMC Canyon, 4-dr Extra Cab, *04-	38 1/4"	971 mm
GREAT WALL V240, 4-dr Double Cab, 09-	38 1/4"	971 mm
GREAT WALL Steed, 4-dr Double Cab, 09-	38 1/4"	971 mm
GREAT WALL Wingle, 4-dr Double Cab, 06-	38 1/4"	971 mm
ISUZU D-max, 4-dr Double Cab, 02-	38 1/4"	971 mm
ISUZU D-max, 4-dr Extended Cab, 02-	38 1/4"	971 mm
ISUZU I-280/I-290, 4-dr Crew Cab, *06-09	38 1/4"	971 mm
ISUZU I-350/I-370, 4-dr Extra Cab, *06-09	38 1/4"	971 mm

4

CHEVROLET Colorado, 4-dr Double Cab, 04–
CHEVROLET Colorado, 4-dr Extended Cab, 04–
CHEVROLET Colorado, 4-dr Crew Cab, *04–
CHEVROLET Colorado, 4-dr Extra Cab, *04–
GMC Canyon, 4-dr Crew Cab, *04–
GMC Canyon, 4-dr Extra Cab, *04–
GREAT WALL V240, 4-dr Double Cab, 09–

GREAT WALL Steed, 4-dr Double Cab, 09–
GREAT WALL Wingle, 4-dr Double Cab, 06–
ISUZU D-max, 4-dr Double Cab, 02–
ISUZU D-max, 4-dr Extended Cab, 02–
ISUZU I-280/I-290, 4-dr Crew Cab, *06-09
ISUZU I-350/I-370, 4-dr Extra Cab, *06-09

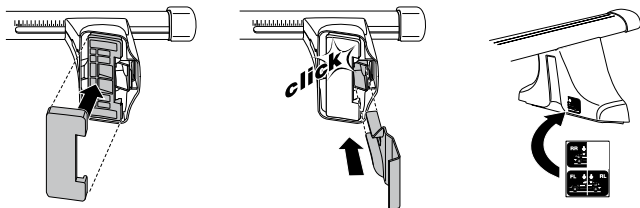
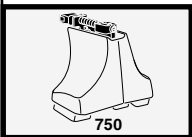
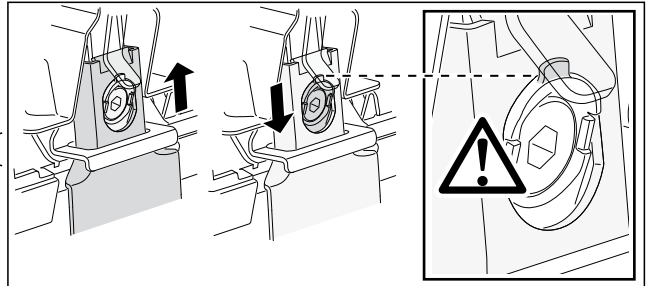
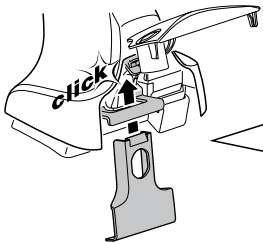
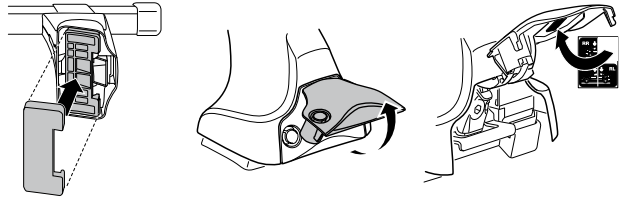
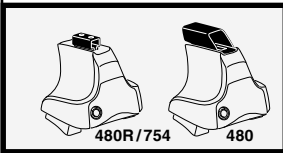
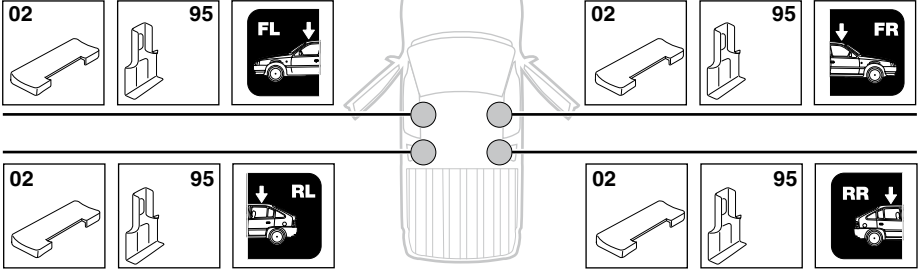

5

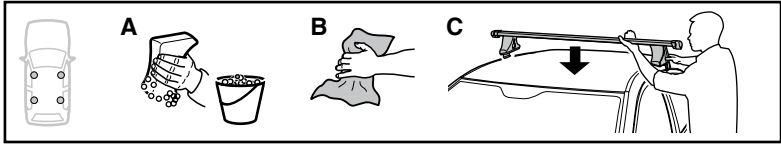

	X mm	Y mm	X inch	Y inch
CHEVROLET Colorado, 4-dr Double Cab, 04-	380 mm	750 mm	15"	29 1/2"
CHEVROLET Colorado, 4-dr Extended Cab, 04-	250 mm	680 mm	9 7/8"	26 3/4"
CHEVROLET Colorado, 4-dr Crew Cab, *04-	380 mm	750 mm	15"	29 1/2"
CHEVROLET Colorado, 4-dr Extra Cab, *04-	250 mm	680 mm	9 7/8"	26 3/4"
GMC Canyon, 4-dr Crew Cab, *04-	380 mm	750 mm	15"	29 1/2"
GMC Canyon, 4-dr Extra Cab, *04-	250 mm	680 mm	9 7/8"	26 3/4"
GREAT WALL V240, 4-dr Double Cab, 09-	380 mm	750 mm	15"	29 1/2"
GREAT WALL Steed, 4-dr Double Cab, 09-	380 mm	750 mm	15"	29 1/2"
GREAT WALL Wingle, 4-dr Double Cab, 06-	380 mm	750 mm	15"	29 1/2"
ISUZU D-max, 4-dr Double Cab, 02-	380 mm	750 mm	15"	29 1/2"
ISUZU D-max, 4-dr Extended Cab, 02-	250 mm	680 mm	9 7/8"	26 3/4"
ISUZU I-280/I-290, 4-dr Crew Cab, *06-09	380 mm	750 mm	15"	29 1/2"
ISUZU I-350/I-370, 4-dr Extra Cab, *06-09	250 mm	680 mm	9 7/8"	26 3/4"

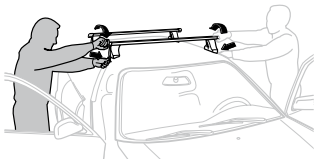
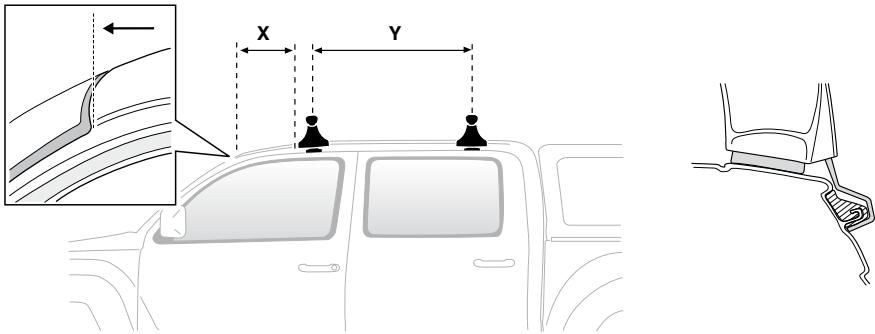

GB/US Tighten alternately
D Die Schrauben abwechselnd anziehen
F Serrer alternativement chaque côté
NL Afwisselend aan de linker- en de rechterkant aandraaien
I Alternare il serraggio delle viti
E Apretar alternativamente
PT Aperte alternadamente
S Dra åt växelvis
FIN Kierrä vuorotellen
EST Pinguldage vaheldumisi
LAT Pievelciēt pamišus
LIT Užsukinėkite pakaitomis
PL Śruby dokręcaj naprzemiennie
RU Затягивайте попеременно

CZ Pokrétla bagazníka dokręcaj dokręcaj naprzemiennie.
SK Dofahujte striedavo
SLO Privijajte izmenično.
HR Naizmjenično zategnite
HU Egymástól függetlenül szorítandó
GR Σφιγγετε εναλλάξ
TR Dönüşümlü sıkın

中文 交替拧紧

한국어 번갈아 가며 조이십시오.

日本語 交互に締め付けてください。

ไทย ขึ้นในแบบสลับ

6

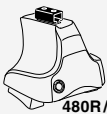

480R/754



480

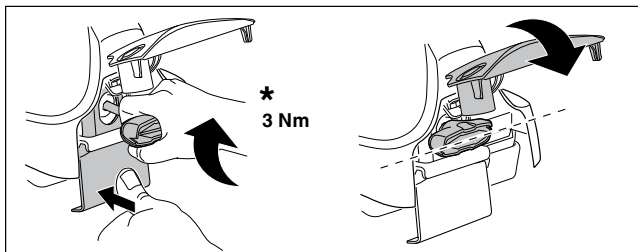
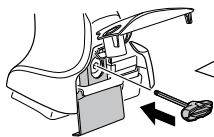

*
3 Nm

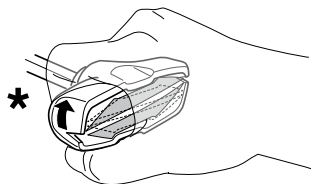

*

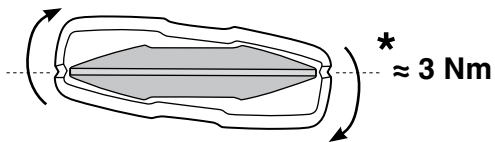

*
≈ 3 Nm

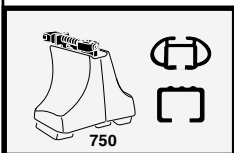
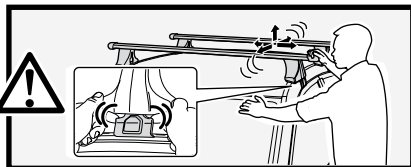

750

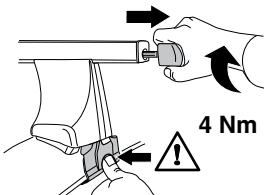

4 Nm

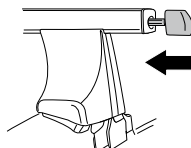

7



x1
17 mm

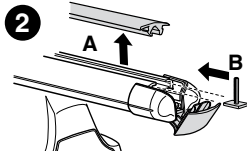
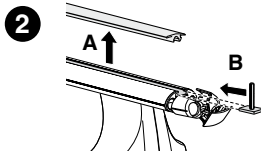
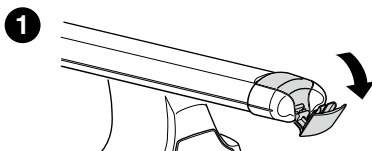
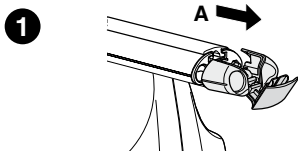
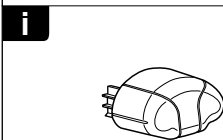
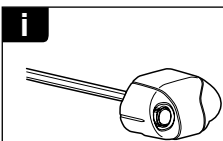
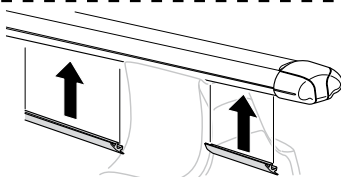

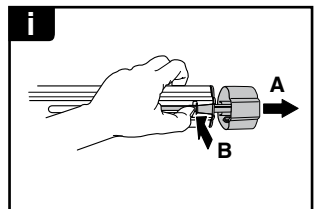
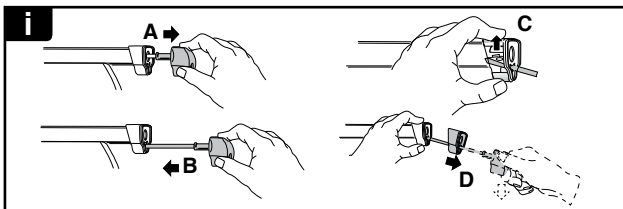
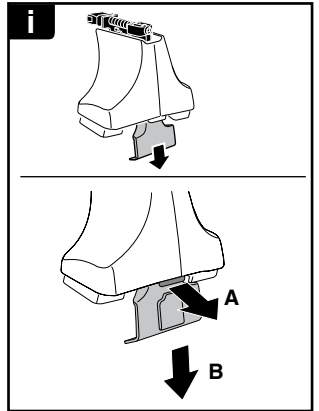
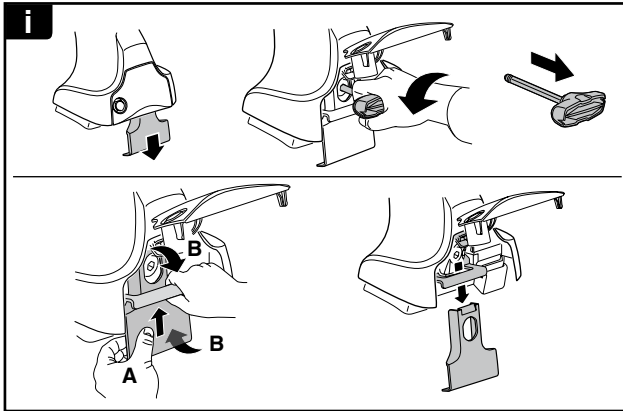
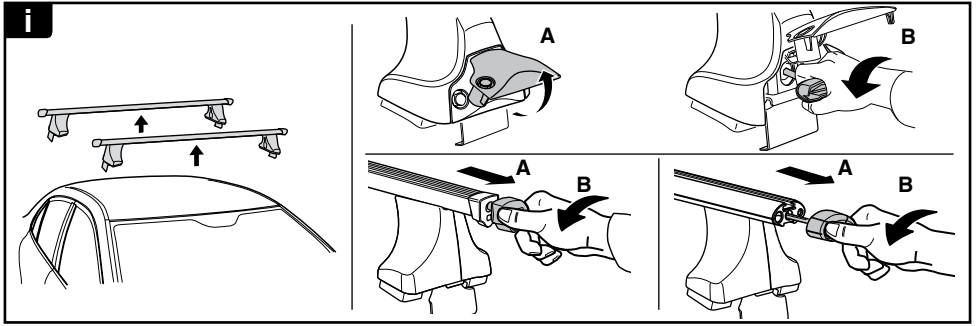

THULE
SWEDEN
**ONE
KEY
SYSTEM**

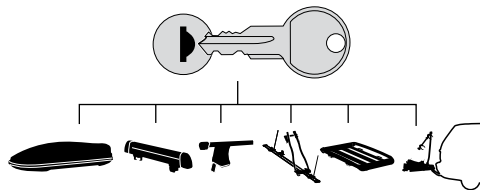

		(x4)
		(x6)
		(x8)
NA		(x10)
EUR		(x12)
ASIA		(x12)

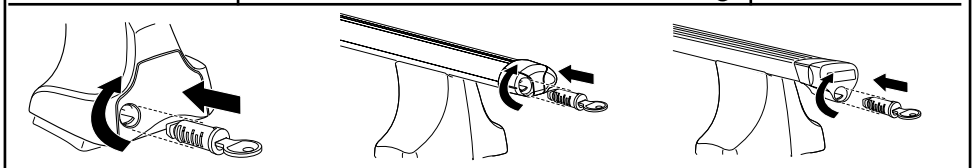



WW ▶ Thule Sweden AB, Box 69, 330 33 Hillerstorp, SWEDEN
NA ▶ Thule Inc., 42 Silvermine Road, Seymour, Connecticut 06483, USA

info@thule.com
customer.service@thule.com

www.thule.com

 www.thuleprofessional.com

 info@thule.com
customer.service@thule.com

 **NA** Thule Sweden AB, Box 69, 330 33 Hillerstorp, SWEDEN
Thule Inc., 42 Silvermine Road, Seymour, Connecticut 06483, USA

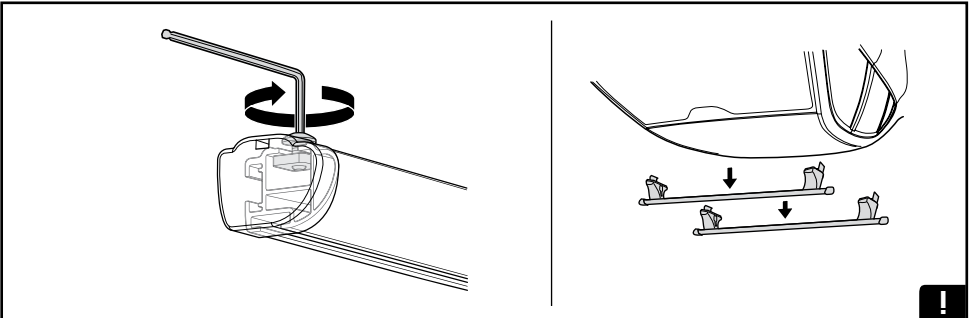
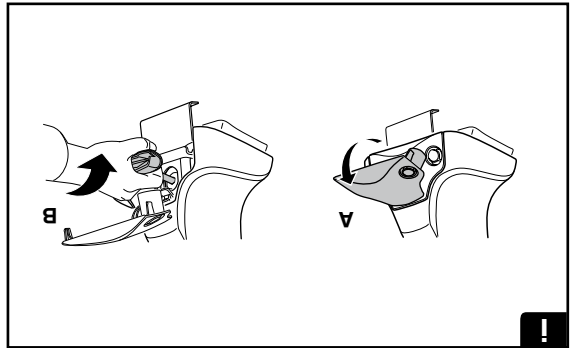
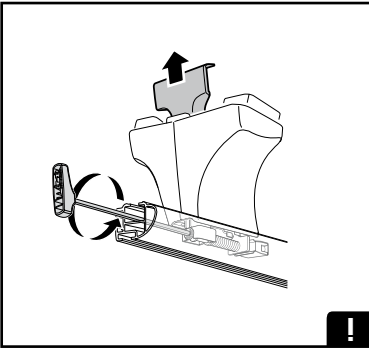
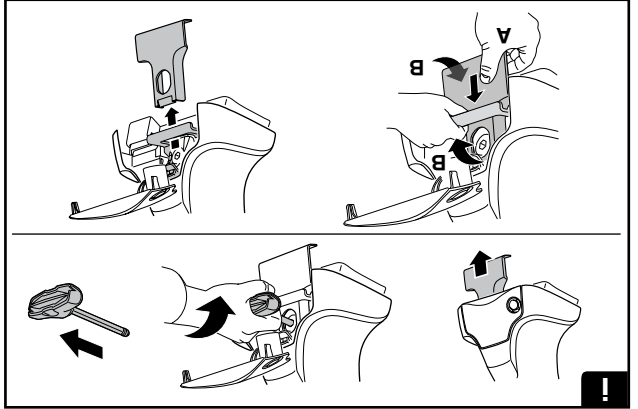
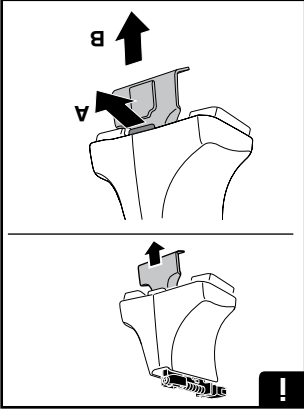

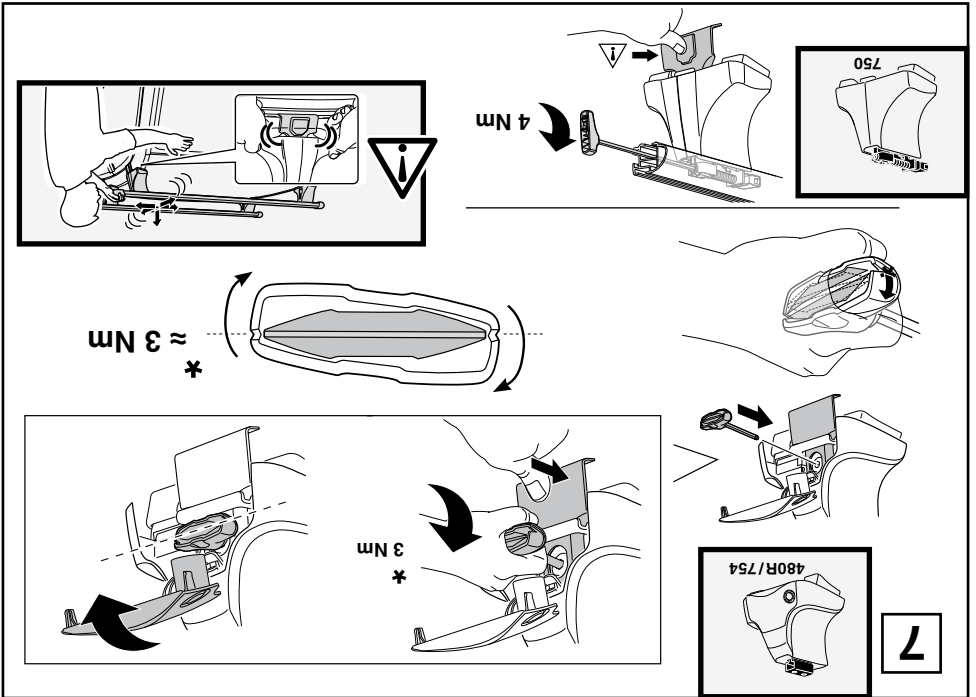
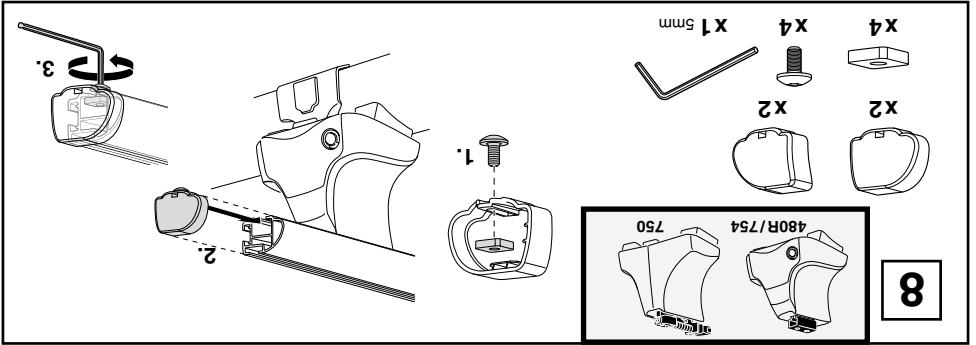
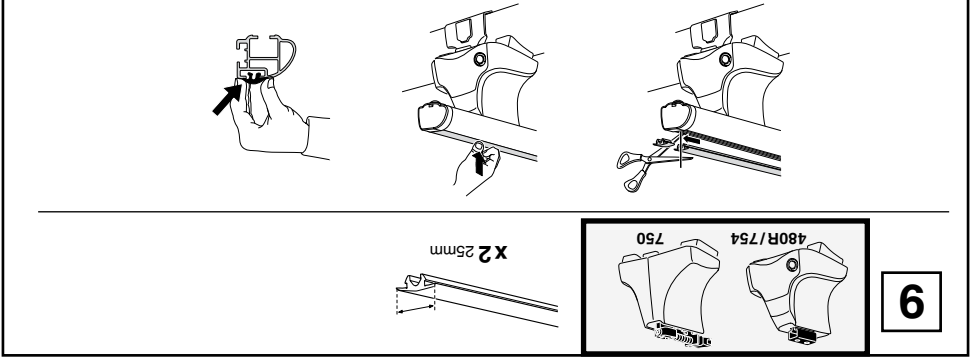

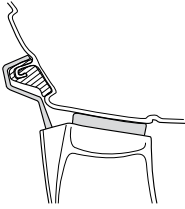
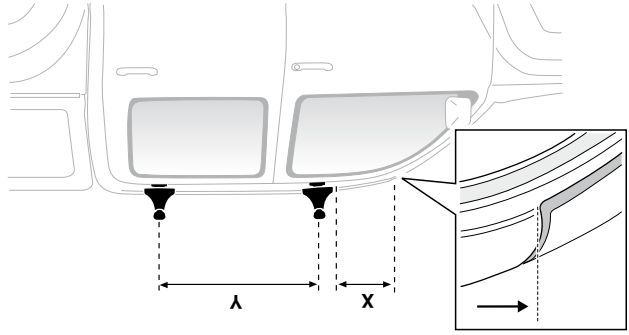
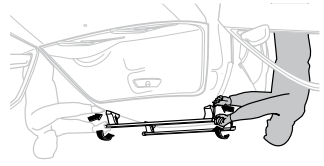

GB/US Tighten alternately
D Die Schrauben abwechselnd
F Serrer alternativement chaque côté
NL Afwisselend aan de linker- en de
I rechtterkant aandraaien
E Apretar alternativamente
PT Apretar alternadamente
S Dra åt växelvis
FIN Kiertä vuorotellen
EST Pingsidage vaheldumisi
LAT Pļevciēti pārmēsus
LIT Užkinkinkite pakaitomis
PL Śruby dokręcać naprzemiennie
RU Затягивайте попеременно

CZ Pokrýtá bagazníka dokręcať dokręcať naprzemiennie.
SK Dotiahnuť striedavo dokręcať naprzemiennie.
HR Naizmjenično zatęgnuti.
HU Egyenletesül ziggetlenül szorítandó.
GR Σφιγγείτε εναλλάξ.
TR Donuşumlu sıkın.
中文 交替拧紧
한국어 가며 조이십시오.
日本語 交互に締め付けてください。
IME փոփոխաբար

CHEVROLET Colorado, 4-dr Double Cab, *04-	380 mm	750 mm	15"	29 1/2"	9 7/8"	26 3/4"
CHEVROLET Colorado, 4-dr Extended Cab, *04-	250 mm	680 mm	9 7/8"	26 3/4"	15"	29 1/2"
CHEVROLET Colorado, 4-dr Crew Cab, *04-	380 mm	750 mm	15"	29 1/2"	9 7/8"	26 3/4"
CHEVROLET Colorado, 4-dr Extra Cab, *04-	250 mm	680 mm	9 7/8"	26 3/4"	15"	29 1/2"
GMC Canyon, 4-dr Crew Cab, *04-	380 mm	750 mm	15"	29 1/2"	9 7/8"	26 3/4"
GMC Canyon, 4-dr Extra Cab, *04-	250 mm	680 mm	9 7/8"	26 3/4"	15"	29 1/2"
GREAT WALL V240, 4-dr Double Cab, *09-	380 mm	750 mm	15"	29 1/2"	9 7/8"	26 3/4"
GREAT WALL Steed, 4-dr Double Cab, *09-	380 mm	750 mm	15"	29 1/2"	9 7/8"	26 3/4"
GREAT WALL Wingle, 4-dr Double Cab, *06-	380 mm	750 mm	15"	29 1/2"	9 7/8"	26 3/4"
ISUZU D-max, 4-dr Double Cab, *02-	380 mm	750 mm	15"	29 1/2"	9 7/8"	26 3/4"
ISUZU D-max, 4-dr Extended Cab, *02-	250 mm	680 mm	9 7/8"	26 3/4"	15"	29 1/2"
ISUZU I-280/I-290, 4-dr Crew Cab, *06-09	380 mm	750 mm	15"	29 1/2"	9 7/8"	26 3/4"
ISUZU I-350/I-370, 4-dr Extra Cab, *06-09	250 mm	680 mm	9 7/8"	26 3/4"	15"	29 1/2"

X mm | Y mm | X inch | Y inch

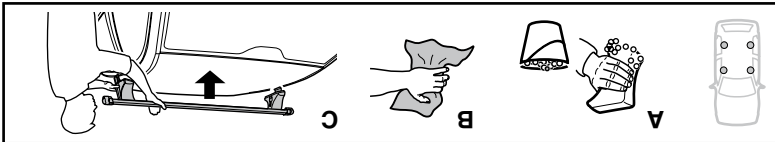

6

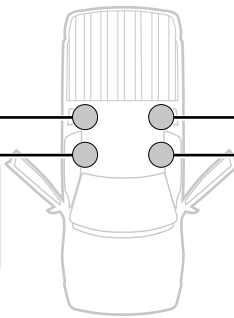
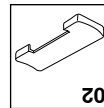
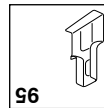
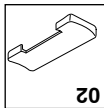
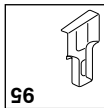
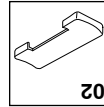
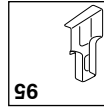
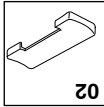
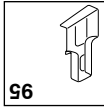
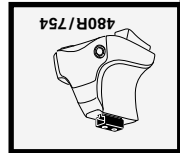
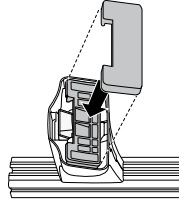
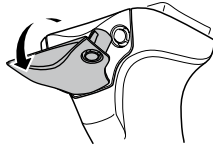
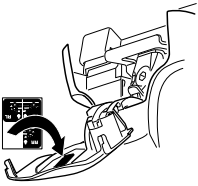
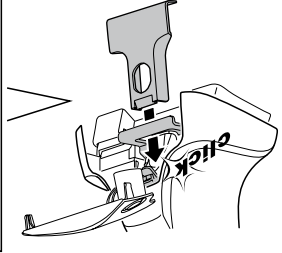
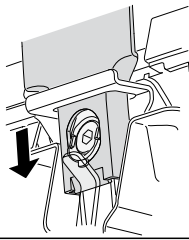
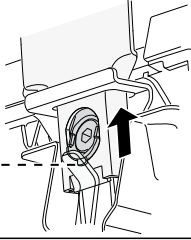
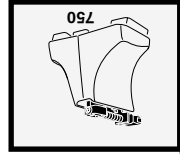
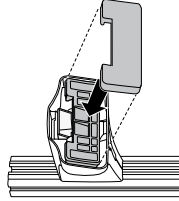
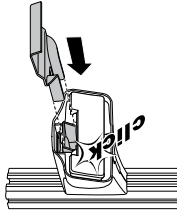
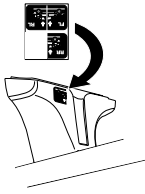

- GREAT WALL Steed, 4-dr Double Cab, 09-
- GREAT WALL Wingle, 4-dr Double Cab, 06-
- ISUZU D-max, 4-dr Double Cab, 02-
- ISUZU D-max, 4-dr Extended Cab, 02-
- ISUZU I-280/I-290, 4-dr Crew Cab, *06-09
- ISUZU I-350/I-370, 4-dr Extra Cab, *06-09
- GREAT WALL V240, 4-dr Double Cab, 09-
- GMC Canyon, 4-dr Extra Cab, *04-
- GMC Canyon, 4-dr Crew Cab, *04-
- CHEVROLET Colorado, 4-dr Extra Cab, *04-
- CHEVROLET Colorado, 4-dr Crew Cab, *04-
- CHEVROLET Colorado, 4-dr Extended Cab, 04-
- CHEVROLET Colorado, 4-dr Double Cab, 04-

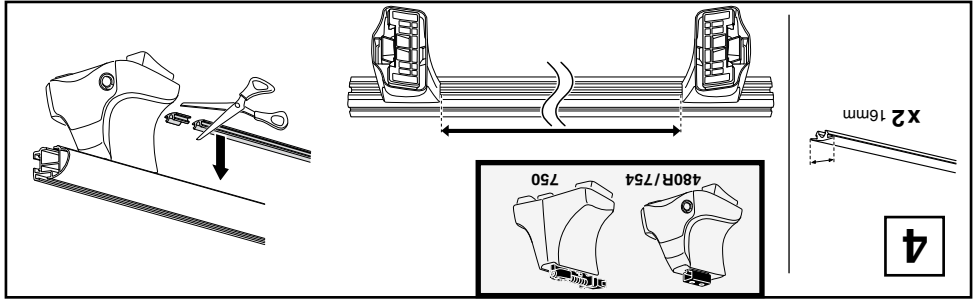

971 mm	38 1/4"	CHEVROLET Colorado, 4-dr Double Cab, 04-
971 mm	38 1/4"	CHEVROLET Colorado, 4-dr Extended Cab, 04-
971 mm	38 1/4"	CHEVROLET Colorado, 4-dr Crew Cab, *04-
971 mm	38 1/4"	CHEVROLET Colorado, 4-dr Extra Cab, *04-
971 mm	38 1/4"	GMC Canyon, 4-dr Crew Cab, *04-
971 mm	38 1/4"	GMC Canyon, 4-dr Extra Cab, *04-
971 mm	38 1/4"	GREAT WALL V240, 4-dr Double Cab, 09-
971 mm	38 1/4"	GREAT WALL Steed, 4-dr Double Cab, 09-
971 mm	38 1/4"	GREAT WALL Wingle, 4-dr Double Cab, 06-
971 mm	38 1/4"	ISUZU D-max, 4-dr Double Cab, 02-
971 mm	38 1/4"	ISUZU D-max, 4-dr Extended Cab, 02-
971 mm	38 1/4"	ISUZU I-280/I-290, 4-dr Crew Cab, *06-09
971 mm	38 1/4"	ISUZU I-350/I-370, 4-dr Extra Cab, *06-09

1

991 mm	39"	CHEVROLET Colorado, 4-dr Double Cab, 04-
991 mm	39"	CHEVROLET Colorado, 4-dr Extended Cab, 04-
991 mm	39"	CHEVROLET Colorado, 4-dr Crew Cab, *04-
991 mm	39"	CHEVROLET Colorado, 4-dr Extra Cab, *04-
991 mm	39"	GMC Canyon, 4-dr Crew Cab, *04-
991 mm	39"	GMC Canyon, 4-dr Extra Cab, *04-
991 mm	39"	GREAT WALL V240, 4-dr Double Cab, 09-
991 mm	39"	GREAT WALL Steed, 4-dr Double Cab, 09-
991 mm	39"	GREAT WALL Wingle, 4-dr Double Cab, 06-
991 mm	39"	ISUZU D-max, 4-dr Double Cab, 02-
991 mm	39"	ISUZU D-max, 4-dr Extended Cab, 02-
991 mm	39"	ISUZU I-280/I-290, 4-dr Crew Cab, *06-09
991 mm	39"	ISUZU I-350/I-370, 4-dr Extra Cab, *06-09

1

2

2

971 mm	38 1/4"	CHEVROLET Colorado, 4-dr Double Cab, 04-
971 mm	38 1/4"	CHEVROLET Colorado, 4-dr Extended Cab, 04-
971 mm	38 1/4"	CHEVROLET Colorado, 4-dr Crew Cab, *04-
971 mm	38 1/4"	CHEVROLET Colorado, 4-dr Extra Cab, *04-
971 mm	38 1/4"	GMC Canyon, 4-dr Crew Cab, *04-
971 mm	38 1/4"	GMC Canyon, 4-dr Extra Cab, *04-
971 mm	38 1/4"	GREAT WALL V240, 4-dr Double Cab, 09-
971 mm	38 1/4"	GREAT WALL Steed, 4-dr Double Cab, 09-
971 mm	38 1/4"	GREAT WALL Wingle, 4-dr Double Cab, 06-
971 mm	38 1/4"	ISUZU D-max, 4-dr Double Cab, 02-
971 mm	38 1/4"	ISUZU D-max, 4-dr Extended Cab, 02-
971 mm	38 1/4"	ISUZU I-280/I-290, 4-dr Crew Cab, *06-09
971 mm	38 1/4"	ISUZU I-350/I-370, 4-dr Extra Cab, *06-09

1

2

2

991 mm	39"	CHEVROLET Colorado, 4-dr Double Cab, 04-
991 mm	39"	CHEVROLET Colorado, 4-dr Extended Cab, 04-
991 mm	39"	CHEVROLET Colorado, 4-dr Crew Cab, *04-
991 mm	39"	CHEVROLET Colorado, 4-dr Extra Cab, *04-
991 mm	39"	GMC Canyon, 4-dr Crew Cab, *04-
991 mm	39"	GMC Canyon, 4-dr Extra Cab, *04-
991 mm	39"	GREAT WALL V240, 4-dr Double Cab, 09-
991 mm	39"	GREAT WALL Steed, 4-dr Double Cab, 09-
991 mm	39"	GREAT WALL Wingle, 4-dr Double Cab, 06-
991 mm	39"	ISUZU D-max, 4-dr Double Cab, 02-
991 mm	39"	ISUZU D-max, 4-dr Extended Cab, 02-
991 mm	39"	ISUZU I-280/I-290, 4-dr Crew Cab, *06-09
991 mm	39"	ISUZU I-350/I-370, 4-dr Extra Cab, *06-09

1

2

2

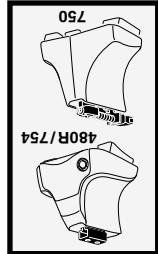

3

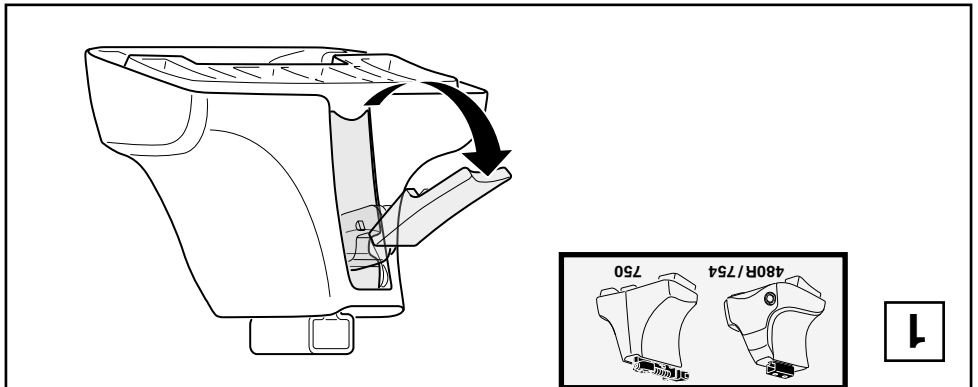
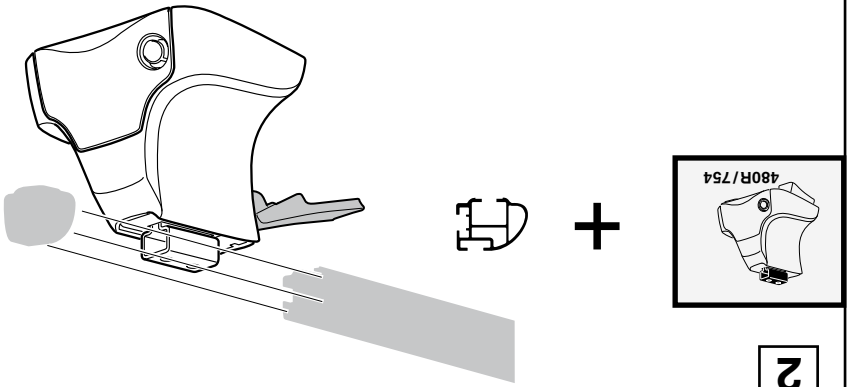
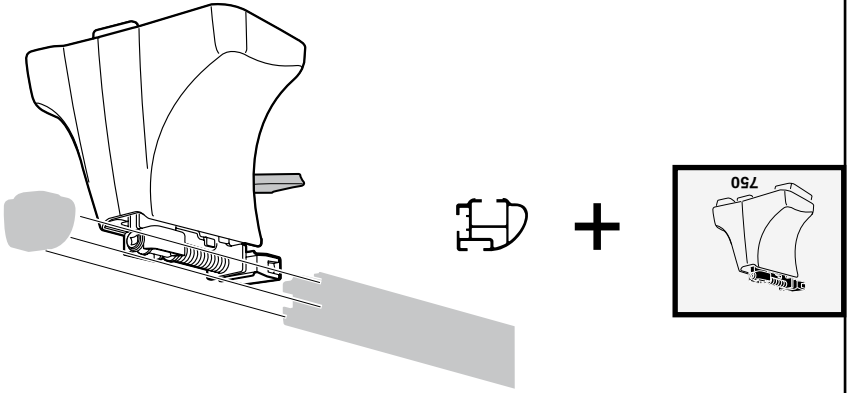

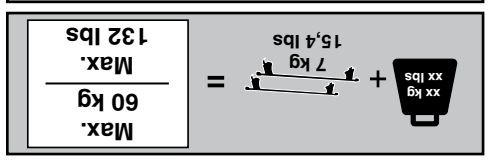
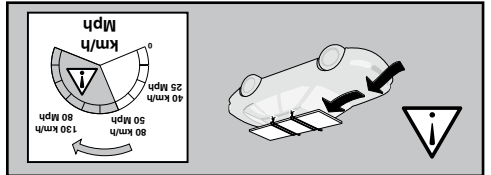
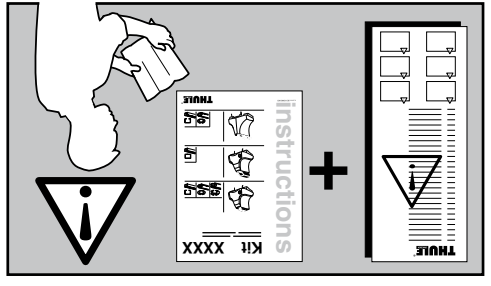
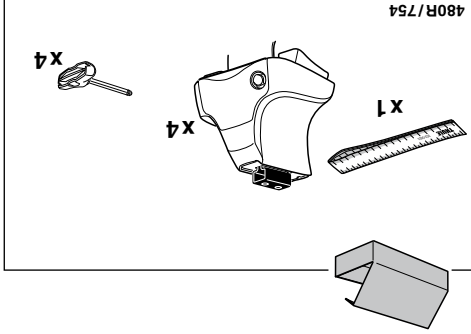
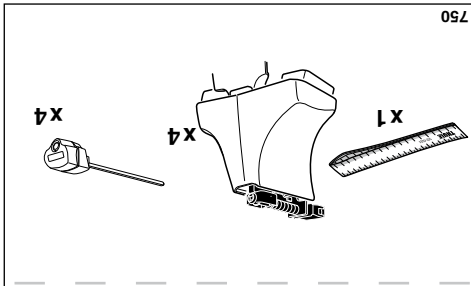
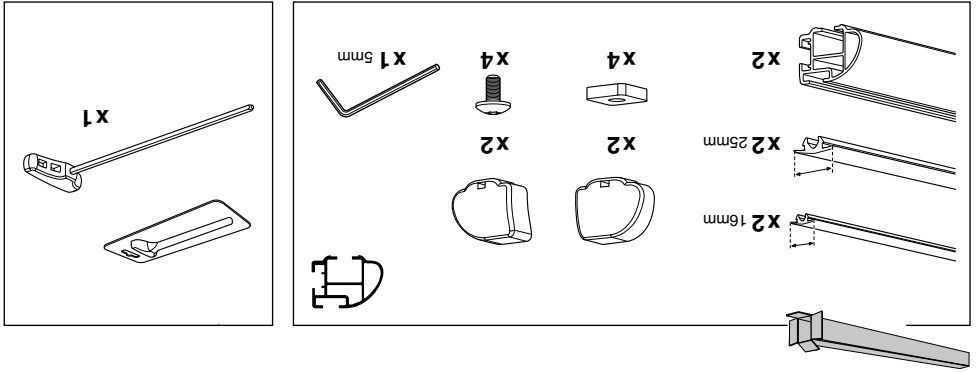
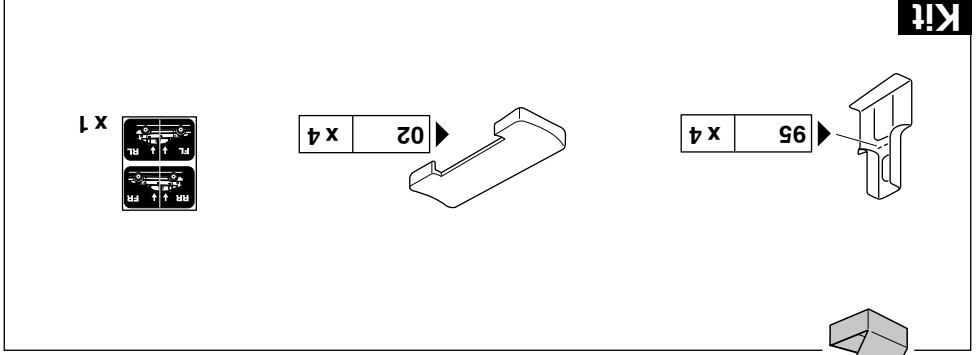

instructions

Kit 1461

- CHEVROLET Colorado, 4-dr Double Cab, 04-
- CHEVROLET Colorado, 4-dr Extended Cab, 04-
- CHEVROLET Colorado, 4-dr Crew Cab, *04-
- CHEVROLET Colorado, 4-dr Extra Cab, *04-
- GMC Canyon, 4-dr Crew Cab, *04-
- GMC Canyon, 4-dr Extra Cab, *04-
- GREAT WALL V240, 4-dr Double Cab, 09-
- GREAT WALL Steed, 4-dr Double Cab, 09-
- GREAT WALL Wingle, 4-dr Double Cab, 06-
- ISUZU D-max, 4-dr Double Cab, 02-
- ISUZU D-max, 4-dr Extended Cab, 02-
- ISUZU I-280/I-290, 4-dr Crew Cab, *06-09
- ISUZU I-350/I-370, 4-dr Extra Cab, *06-09

*North America

480R
754

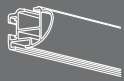
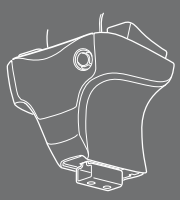

750

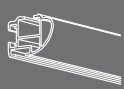
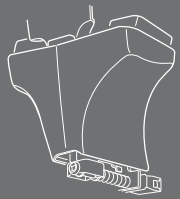

PROFESSIONAL

ISO 11154-E

THULE[®]
SWEDEN