

# Kit 3096

**NISSAN Interstar**, 4-dr Van, 10-  
**OPEL Movano**, 4-dr Van, 10-  
**RENAULT Master**, 4-dr Van, 10-

This Kit is only for vehicles with fixpoint mounting.

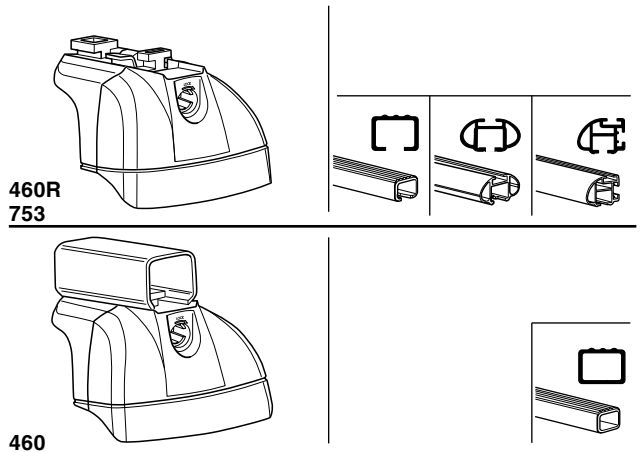

6 kg / 13 lbs + xx kg xx lbs =

**Max. 100 kg**  
**Max. 220 lbs**

9 kg / 20 lbs + xx kg xx lbs =

**Max. 150 kg**  
**Max. 330 lbs**

12 kg / 26 lbs + xx kg xx lbs =

**Max. 200 kg**  
**Max. 440 lbs**

THULE + Kit XXXX

instructions

THULE

80 km/h 130 km/h  
50 Mph 80 Mph  
40 km/h 25 Mph

km/h  
Mph

A B C

50575 x 8

51293 x 1

51325 x 8

30146 x 8

Kit

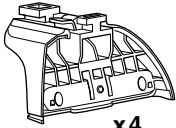
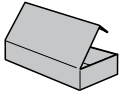

753

x4



x4



x4



16 mm  
x8



5 mm  
x1



x4



x1

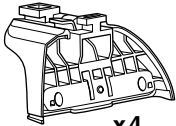

460R

x4



x4



x4



16 mm  
x8

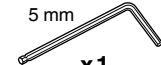

5 mm  
x1



x4

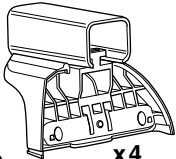

460

x4

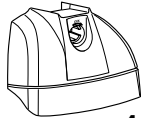

x4



x4



16 mm  
x8

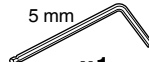

5 mm  
x1



x4



x2



x1

17 mm



x2

23 mm



x2

23 mm



x2



x2

17 mm

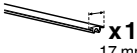

x2

23 mm

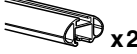

x2

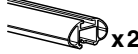

x2

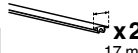

x2

25 mm



x2



x4

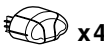

x4



x4



x2

x2

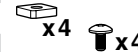

x4

x4



x1

5 mm

1

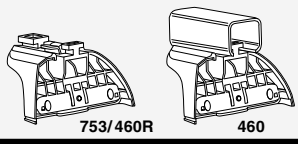

x4

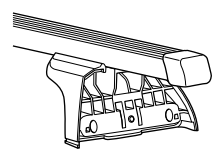
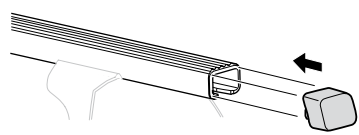

x4

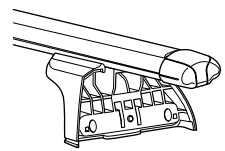
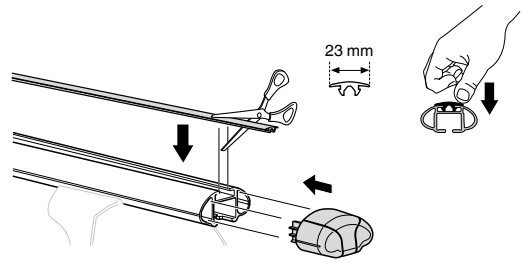



x4

x4

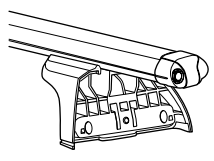
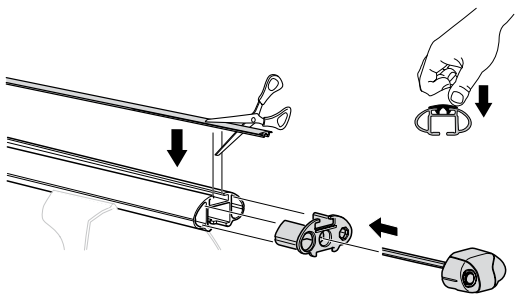

x4

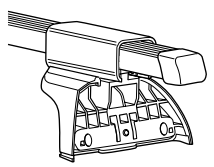
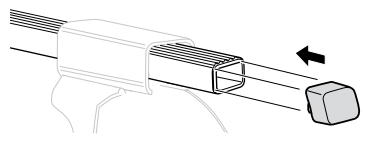

x2

x2

x4

x4

x1  
5 mm

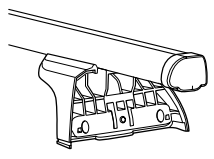
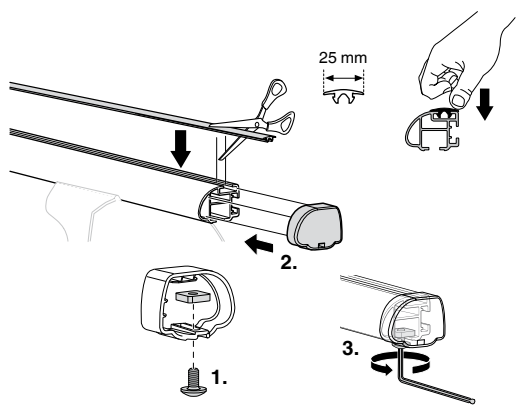

2

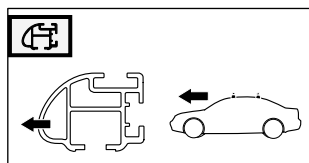
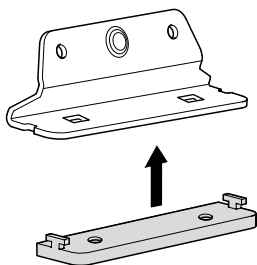
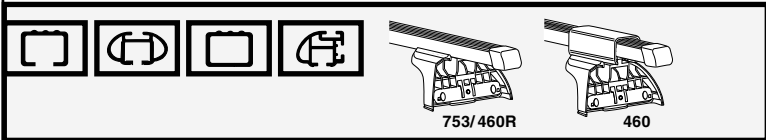
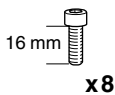
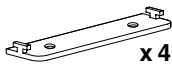
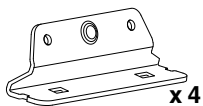

**i**

- GB** Only a few turns
- D** Nur wenige Umdrehungen
- F** Quelques tours uniquement
- NL** Slechts enkele slagen
- I** Solo qualche giro
- E** Sólo algunas vueltas
- PT** Noções básicas
- S** Endast några varv
- FIN** Vain muutama kierros
- EST** Ainult mõni pööre
- LAT** Tikai daži apgriezieni
- LIT** Tik keli pasukimai
- PL** Wystarczy kilka obrotów
- RU** Достаточно нескольких оборотов
- CZ** Pouze několik otáček
- SK** Len niekoľko otáčok
- SLO** Le nekaj obratov
- HR** Samo nekoliko okreta
- HU** Csak néhány fordítás
- GR** Μόνο μερικές στροφές
- TR** Yalnız birkaç kez çevirm
- 中文** 只有几个转向
- 한국어** 두 세번만
- 日本語** 数回転のみ
- ไทย** หมุนเพียงไม่กี่รอบ

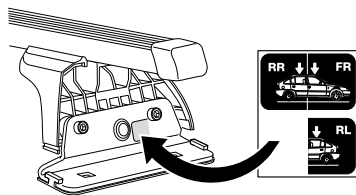
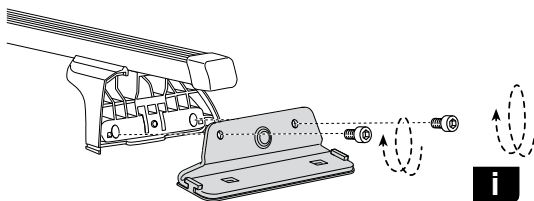

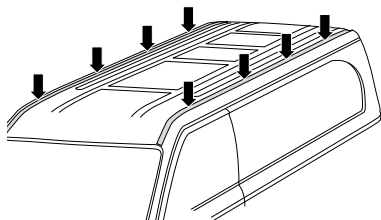
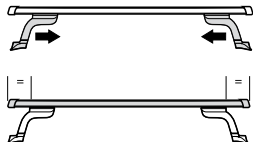
**3****x8****x8****x8**

**GB** If there is an interior roof lining, remove it before starting the installation procedure.

**D** Vor Montagebeginn muß ggf. das Innendach gelöst werden.

**F** Si l'habitacle comporte un pavillon séparé, le déposer avant de commencer le montage.

**NL** Als er een binnendak aanwezig is, maak dit dan los voordat u met de montage begint.

**I** Rimuovere l'eventuale modanatura interna del tetto prima di iniziare la procedura di installazione.

**E** Si hay un techo interior, soltarlo antes de empezar el montaje.

**S** Om det finns ett inmertak, lossa detta innan monteringen påbörjas.

**FIN** Jos autossa on sisäkatto, irrota se ennen asennuksen aloittamista.

**EST** Kui eksisteerib sisemine katusevooderdis, eemaldage see enne paigaldamisega alustamist.

**PL** Przed rozpoczęciem montażu usuń ewentualną spodnią część dachu samochodu.

**RU** В случае наличия на крыше декоративных накладок, перед началом установки их необходимо снять

**CZ** V případě, že vozidlo je vybaveno vnitřním stropem musí být tento před montáží odmontován.

**SLO** Pred pritrdjevanjem odstranite notranjo strešno oblogo, če jo vozilo ima.

**HU** Abban az esetben ha a rögzítés helyén belső közbetételek találunk, azt a rögzítés előtt távolítsuk el.

**한국어** 내부 루프 라이닝이 있는 경우, 설치를 시작하기 전에 분리하십시오.

**日本語** 内側に屋根の裏張りがある場合は、取付手順を開始する前に取り外してください。

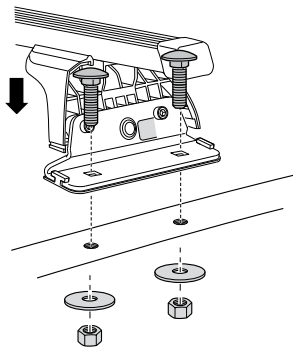
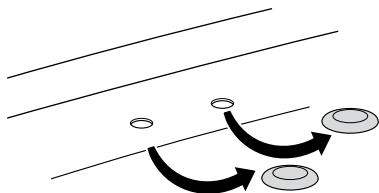
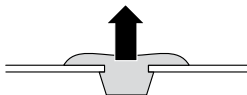
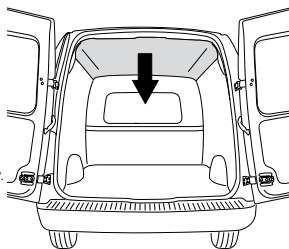

**5**

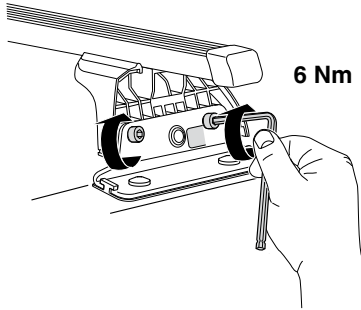
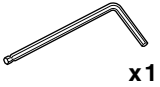
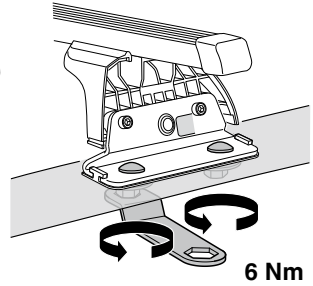
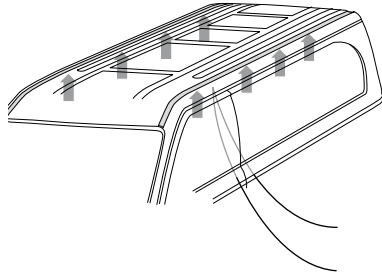
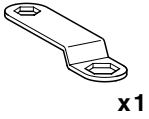

**6**



753

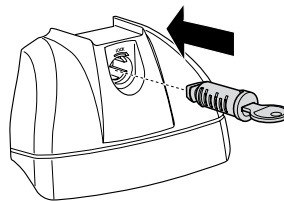

460/460R

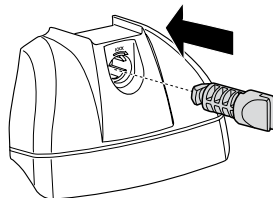



**7**



753 x4

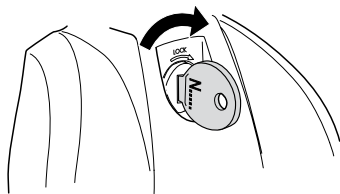
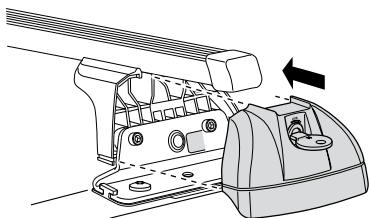

460/460R x4

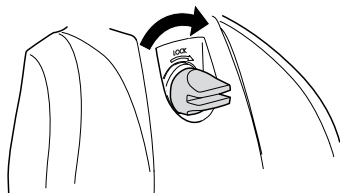
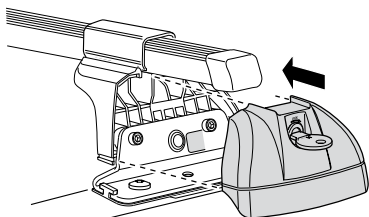

**8**

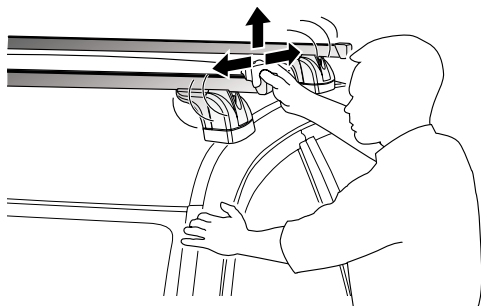





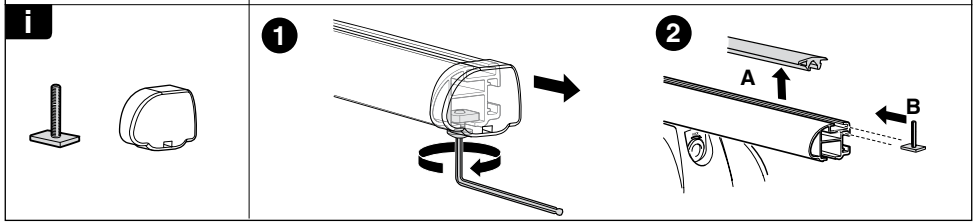
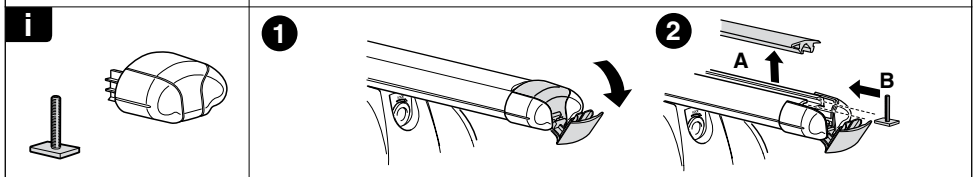
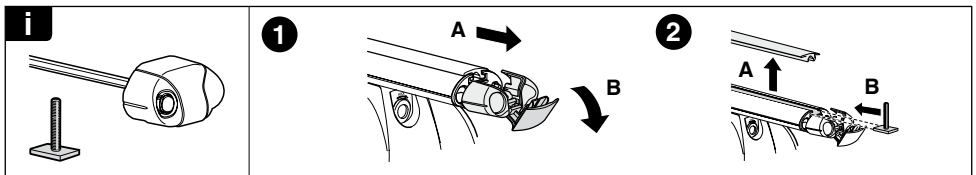
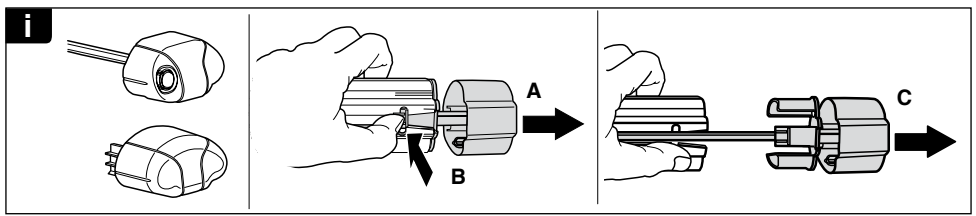
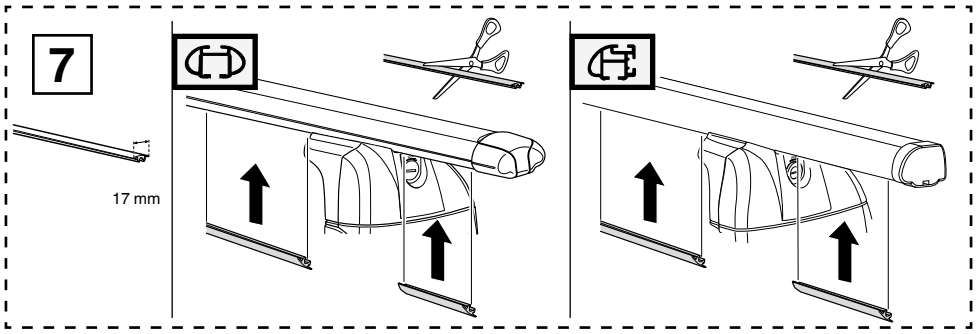

**THULE**  
SWEDEN

**ONE  
KEY  
SYSTEM**

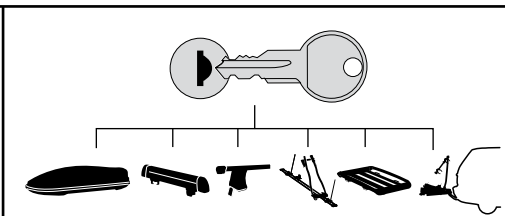

- 544** (x4)
  - 596** (x6)
  - 588** (x8)
  - 510** (x10)
  - 452** (x12)
- NA  
EUR  
ASIA