













Cruzber S.A., ES-A14018311
P.I. Las Salinas II, E-14960 Rute
www.cruzber.com







Código Code Code Kode	932-288		
	Lv 7 2015 - r 4		
Lote Lot Lot Lot	01 -13	Peso Weight Poids Gewicht	0,85 kg
  			
<i>Kit tipo</i> L <i>Kit type</i> <i>Kit type</i> <i>Kit Typ</i>			
Código Homologación ECE R 26.03 R 26.03 ECE Type Approval Number		E9-26R-03.3015	

- (E)** Instrucción de montaje
¡Leer primero!
- (GB)** Assembly instructions
Read first!
- (F)** Instruction de montage
Lire en premier!
- (D)** Montageanleitung
Zuerst lesen!
- (PT)** Instruções de montagem
Ler primeiro!
- (PL)** Instrukcja montażu
Najpierw przeczytaj!
- (CZ)** Montážní návod
Čtěte pozorně!
- (HU)** Szerelési Utasítás
Először olvasd el!
- (RO)** Instrucțiuni de montaj
Intai cititi!
- (HR)** Detaljne upute
Prvo pročitati!
- (GR)** Διαβάστε προσεκτικά τις
Οδηγίες Συναρμολόγησης!
- (TR)** Öncelikli montaj:
Talimatlarını okuyunuz!
- (RU)** Инструкции по монтажу
Сначала прочитайте!
- (IT)** Istruzioni di montaggio
Leggere per primo!
- (NL)** Montagehandleiding
Eerst lezen!
- (SLO)** Navodila za sestavljanje
Preberite!

- Kit fijación
- Fixation Kit
- Kit fixation
- Stützfuß-Kit
- Kit fixação
- Element mocujący
- Fixační kit
- Rögzítő készlet
- Kit de fixare
- Kit za montažu
- Κιβώτιο (Kit) Επισκευής
- Montaj kiti
- Крепежный комплект
- Kit di fissaggio
- Bevestigingsset
- Kit za pričvrstitev

	1°		
	2°		
			

- (E)** Contenido embalaje: ¡Verificar!
- (GB)** Package content: Check!
- (F)** Contenu d'emballage: Vérifier!
- (D)** Packungsinhalt: Überprüfen!
- (PT)** Contéudo embalagem: Verificar!
- (PL)** Zawartość opakowania: sprawdzić!
- (CZ)** Obsah balení: Zkontrolujte!
- (HU)** Csomag tartalma: Ellenőrizd!
- (RO)** Pachetul contine: Verificati!
- (HR)** Sadržaj paketa: Provjeri!
- (GR)** Ελέγξτε το περιεχόμενο: του πακέτου!
- (TR)** Paket içeriğini: Control ediniz!
- (RU)** Содержание упаковки: Проверьте!
- (IT)** Contenuto della confezione: Controllare!
- (NL)** Pakket inhoud: Controleer!
- (SLO)** Vsebina paketa: Preverite!

x 1 	x 1 	x 1  (018-041)	x 4  (815-276)
x 4  (813-002)	x 1  (001-820)		

Código
Code
Code
Kode

932-288

Lv 7 2015 - r 4



Importante!
Important!
Important!
Wichtig!

- E** ¡Este Kit de fijación tiene que usarse con sistemas portacargas Cruz!
- GB** This fixation Kit must be used with Cruz roof rack systems!
- F** Cet Kit de fixation devra être utilisé avec les systèmes portecharge Cruz!
- D** Dieser Stützfuß-Kit muß mit Cruz Dachträgersystemen benutzt werden!
- PT** Este Kit de fixação deve ser utilizado com os sistemas porta cargas Cruz!
- PL** Niniejszy element mocujący musi być używany z systemami bagażników dachowych firmy Cruz!
- CZ** Tento fixační kit musí být používán s nosným systémem Cruz!
- HU** Ez a rögzítő készlet csak a Cruz rendszerekkel használható!
- RO** Acest Kit de fixare, trebuie utilizat cu sisteme Cruz!
- HR** Kit za montažu mora biti korišten uz Cruz sistem krovnog nosača!
- GR** Το αξεσουάρ αυτό θα πρέπει να χρησιμοποιείται αποκλειστικά στα συστήματα μπαρών της Cruz!
- TR** Bu aksesuar mutlaka Cruz taşıma sistemleriyle kullanılmalıdır!
- RU** Крепежный комплект должен быть использован с багажной системой на крышу марки Cruz!
- IT** Questo accessorio deve essere usato con i portapacchi Cruz!
- NL** Deze bevestigingsset moet worden gebruikt in combinatie met Cruz dakdrager systeem!
- SLO** Prečke je potrebno uporabiti s Cruz kiti za pričvrščanje

1

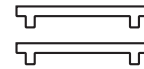

1

2

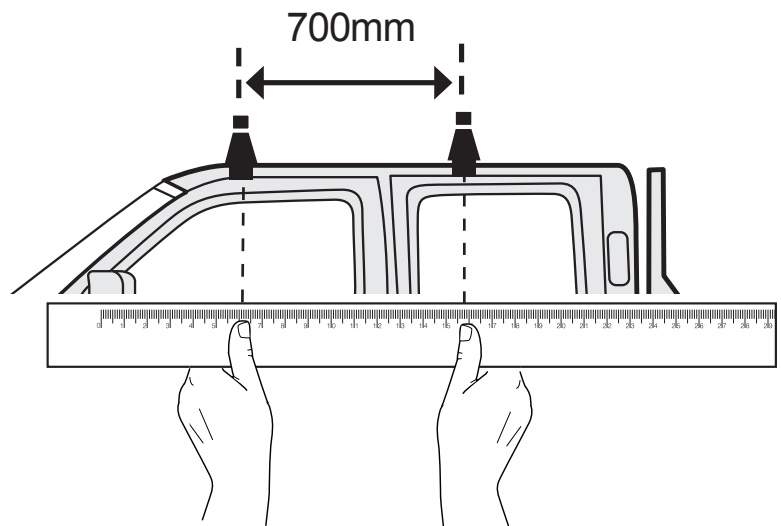

3

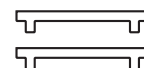

3