



940-424

Lv7 2019-r5

(E)	Instrucción de montaje ¡Leer primero!	Accesorio
(GB)	Assembly instructions Read first!	Accessory
(F)	Instruction de montage Lire en premier!	Accessoire
(D)	Montageanleitung Zuerst lesen!	Zubehör
(PT)	Instruções de montagem Ler primeiro!	Accesório
(PL)	Instrukcja montażu Najpierw przeczytaj!	Wyposażenie
(CZ)	Montážní návod Čtěte pozorně!	Příslušenství
(HU)	Szerelési Utasítás Először olvassd el!	Kiegészítő
(RO)	Instructiuni de montaj Intai cititi!	Dodaci
(HR)	Detaljne upute Prvo pročitati!	Accesoriju
(GR)	Διαβάστε προσεκτικά τις Οδηγίες Συναρμολόγησης!	Αξεσουάρ
(TR)	Öncelikle montaj: Talimatlarını okuyunuz!	Aksesuar
(RU)	Инструкции по монтажу Сначала прочитайте!	Аксессуары
(I)	Istruzioni di montaggio Leggere per primo!	Accessori
(NL)	Montagehandleiding Eerst lezen!	Accessoires
(SLO)	Navodila za sestavljanje Preberite!	Dodatna oprema

Lote-Lot-Lot-Lot:

01-14

Peso-Weight-Poids-Gewicht:

0,18 kg

CRUZBER SA
ES-A14018311
P.I. Las Salinas II
14960 - Rute - Spain
www.cruzber.com



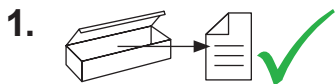

x1



x1



(857-009)



**Importante!
Important!
Important!
Wichtig!**

(E) ¡Este Kit de fijación tiene que usarse con sistemas portacargas Cruz!

(GB) This fixation Kit must be used with Cruz roof rack systems!

(F) Cet Kit de fixation devra être utilisé avec les systèmes porte-charge Cruz!

(D) Dieser Stützfuß-Kit muß mit Cruz Dachträgersystemen benutzt werden!

(PT) Este Kit de fixação deve ser utilizado com os sistemas porta cargas Cruz!

(PL) Niniejszy element mocujący musi być używany z systemami bagażników dachowych firmy Cruz!

(CZ) Tento fixační kit musí být používán s nosným systémem Cruz!

(HU) Ez a rögzítő készlet csak a Cruz rendszerekkel használható!

(RO) Acest Kit de fixare, trebuie utilizat cu sisteme Cruz!

(HR) Kit za montažu mora biti korišten uz Cruz sistem krovnog nosača!

(GR) Το αξεσουάρ αυτό θα πρέπει να χρησιμοποιείται αποκλειστικά στα συστήματα μπαρών της Cruz!

(TR) Bu aksesuar mutlaka Cruz taşıma sistemleriyle kullanılmalıdır!

(RU) Крепежный комплект должен быть использован с багажной системой на крыше марки Cruz!

(IT) Questo kit di fissaggio deve essere usato con i portapacchi Cruz

(NL) Deze bevestigingsset moet worden gebruikt in combinatie met Cruz dakdrager systeem!

(SLO) Kit za pričvrstitev naj se uporablja le z izdelki iz asortimana strešnih košar Cruz!

 **Importante!**
Important!
Important!
Wichtig!

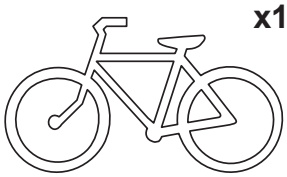

 **Max: 15 kg**

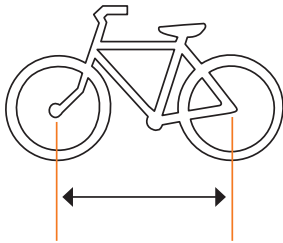

Max: 1150 mm

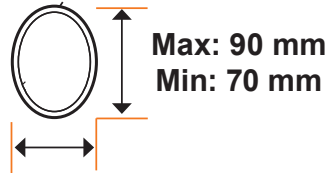
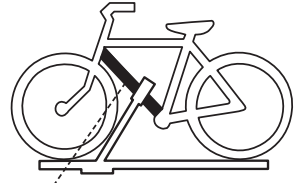

Max: 80 mm
Min: 30 mm

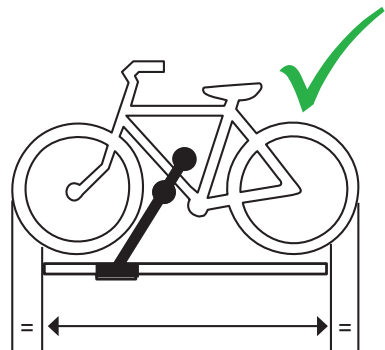
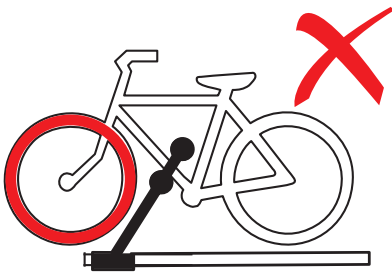

3. 

940-010

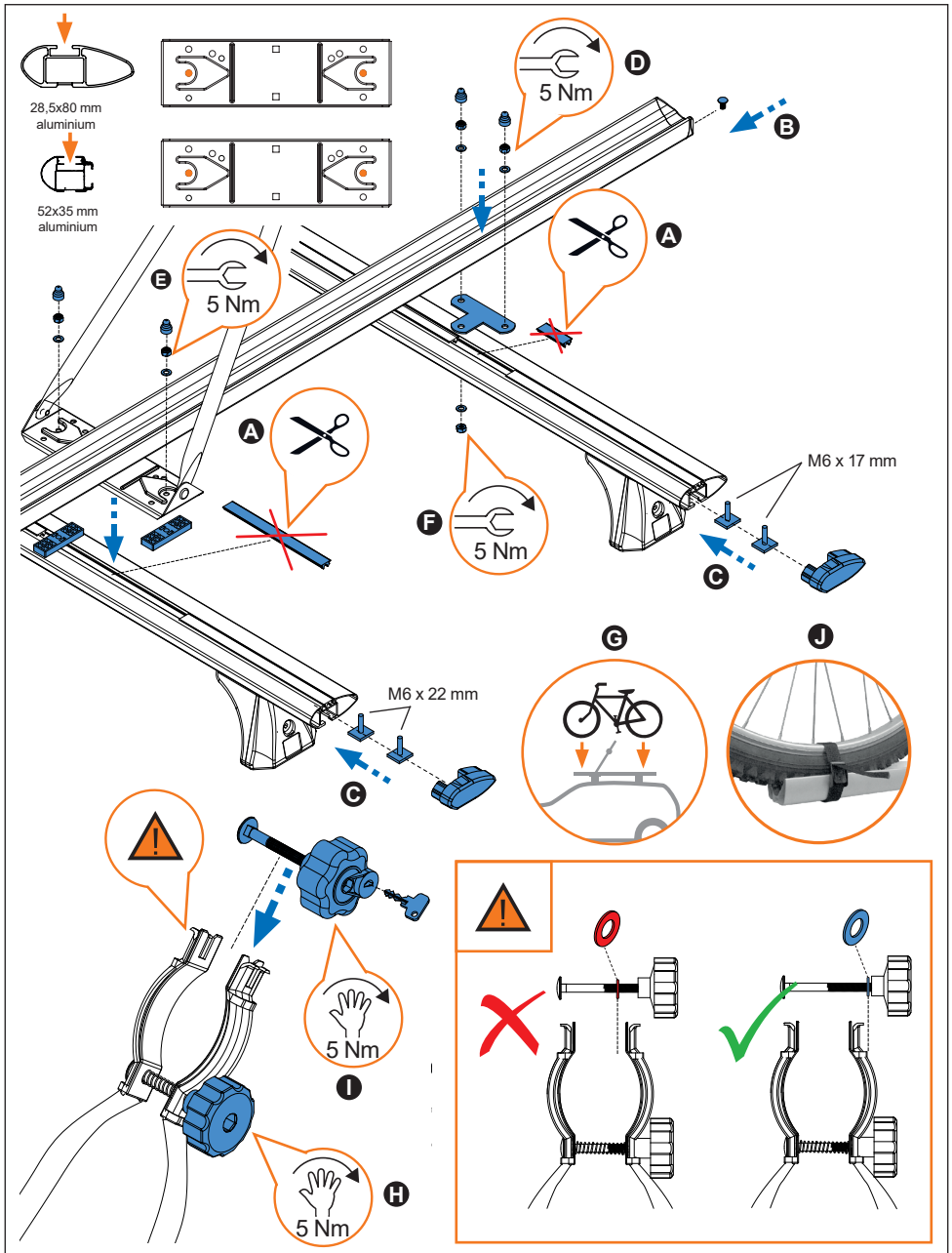

4. 

940-001
940-005

 **Importante!**
Important!
Important!
Wichtig!

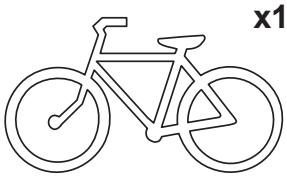

 **Max: 15 kg**

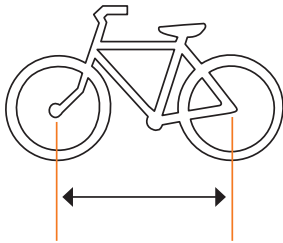

Max: 1150 mm

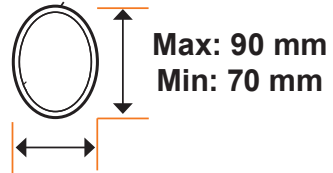
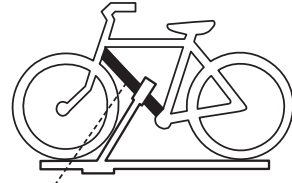

Max: 80 mm
Min: 30 mm

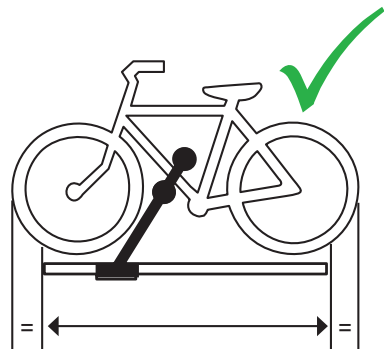
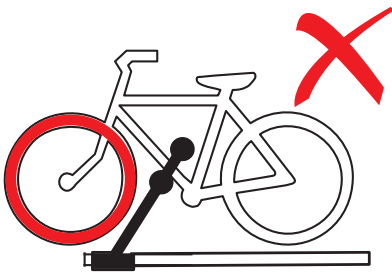

5. 

940-001
940-005

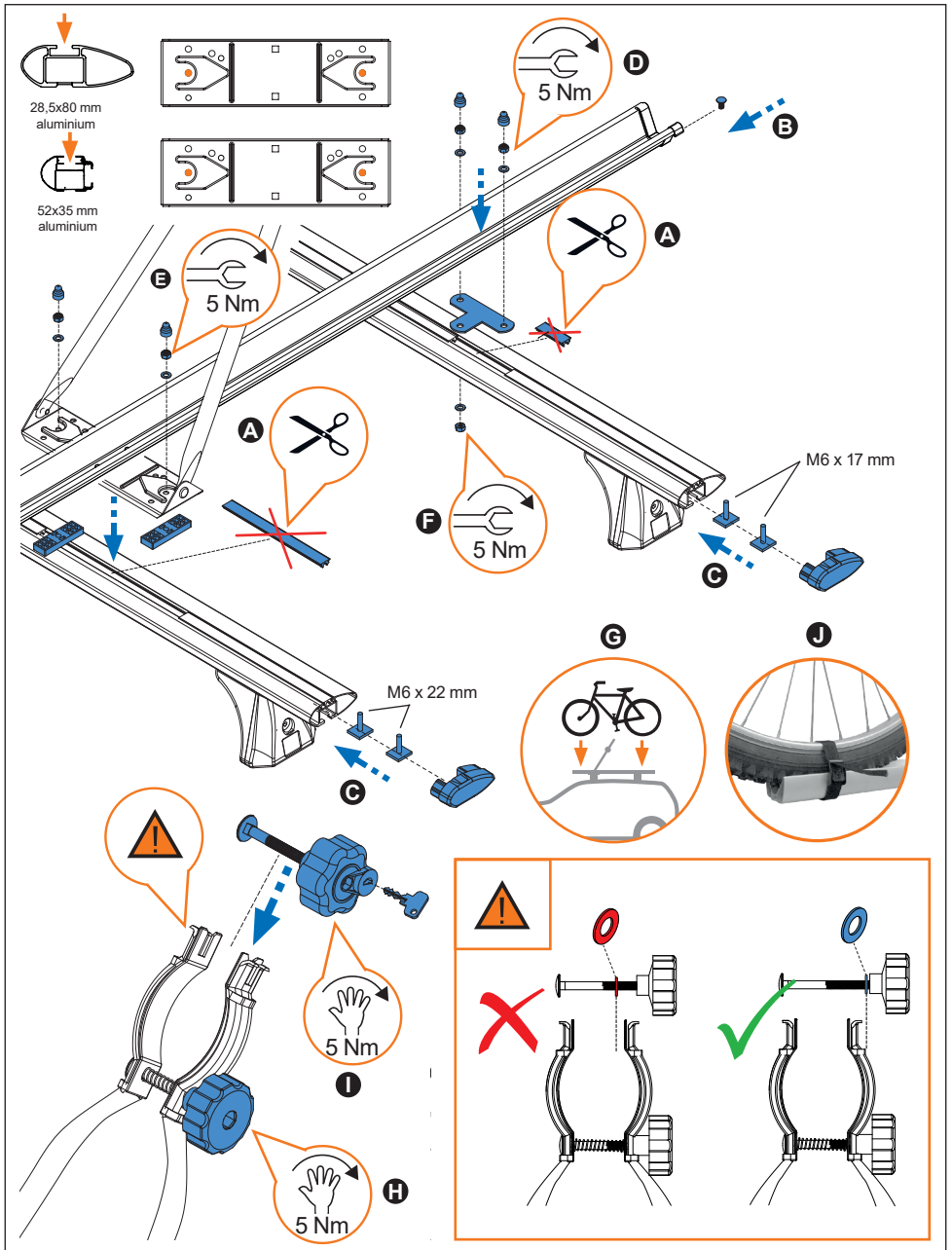

6. 

940-011
940-013

 **Importante!**
Important!
Important!
Wichtig!

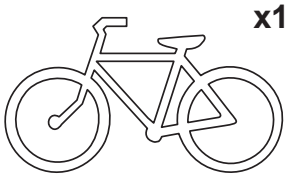

 **Max: 18 kg**

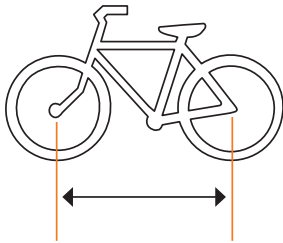

Max: 1150 mm

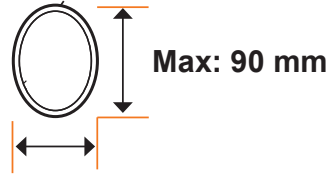
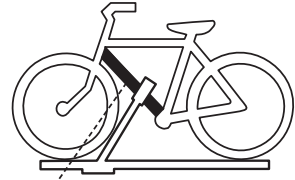

Max: 80 mm

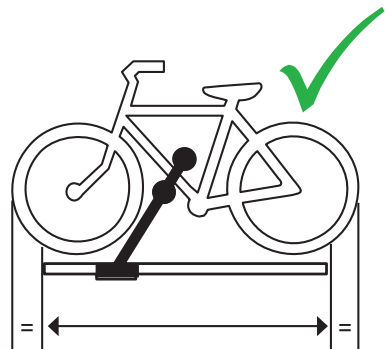
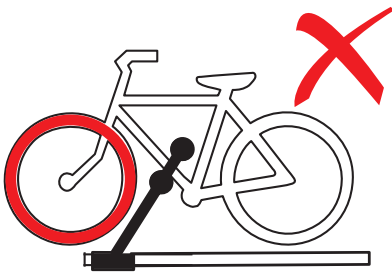

7. 

940-011
940-013

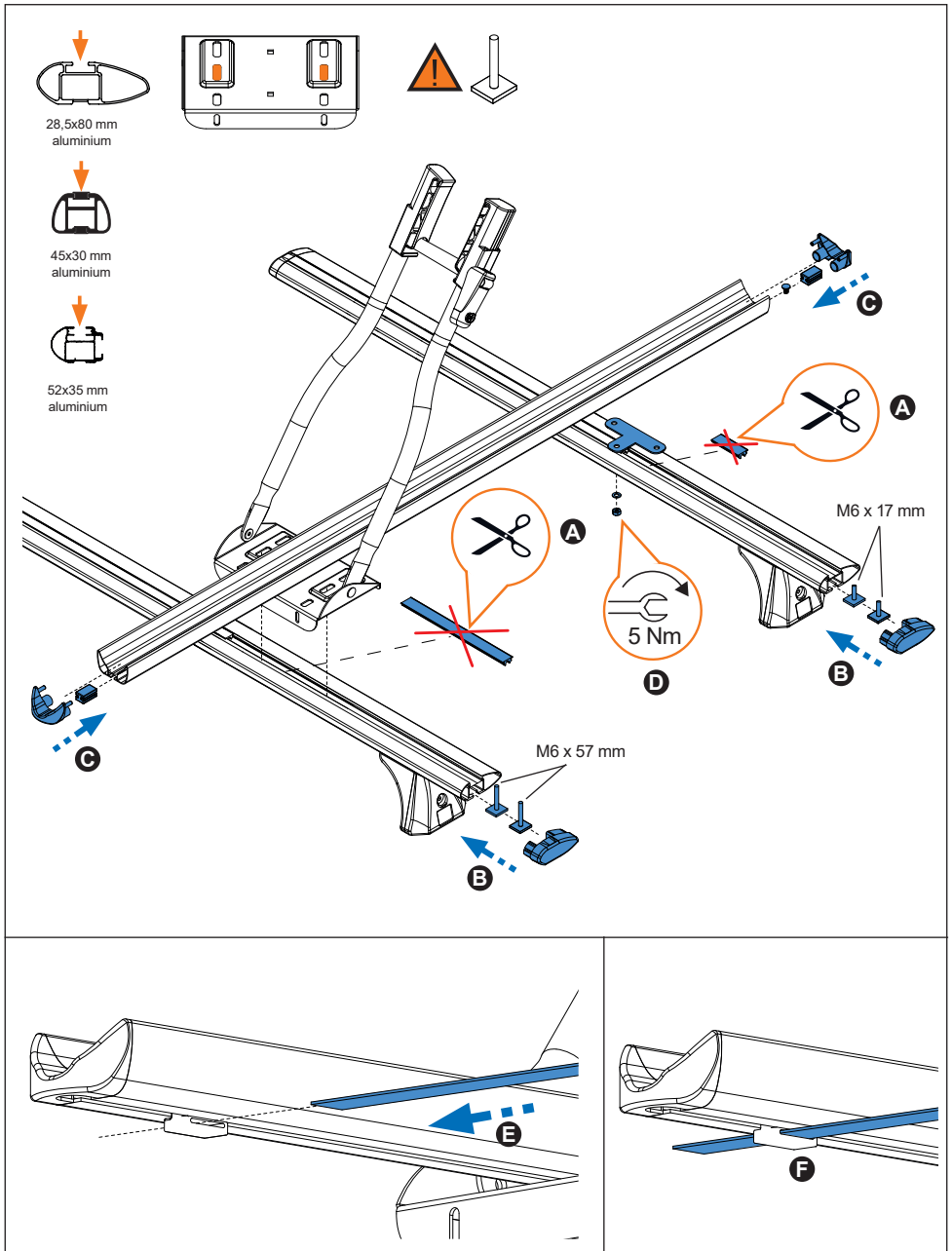

8. 

940-011
940-013

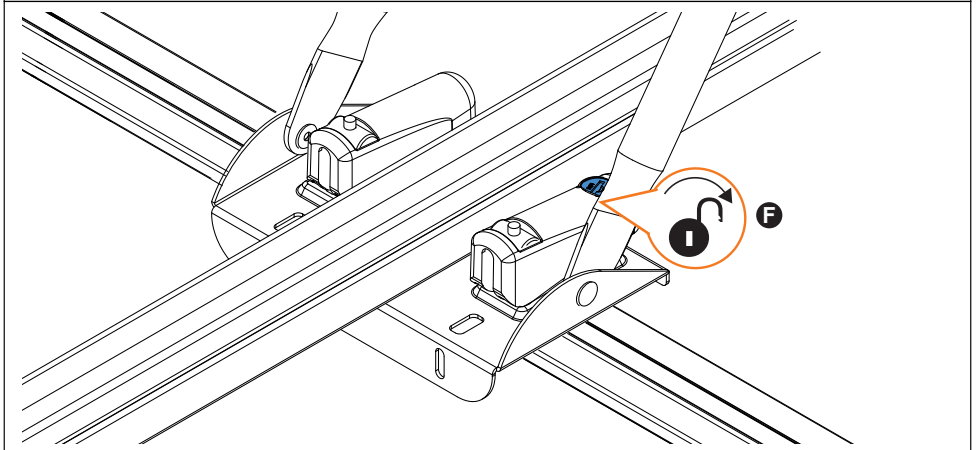
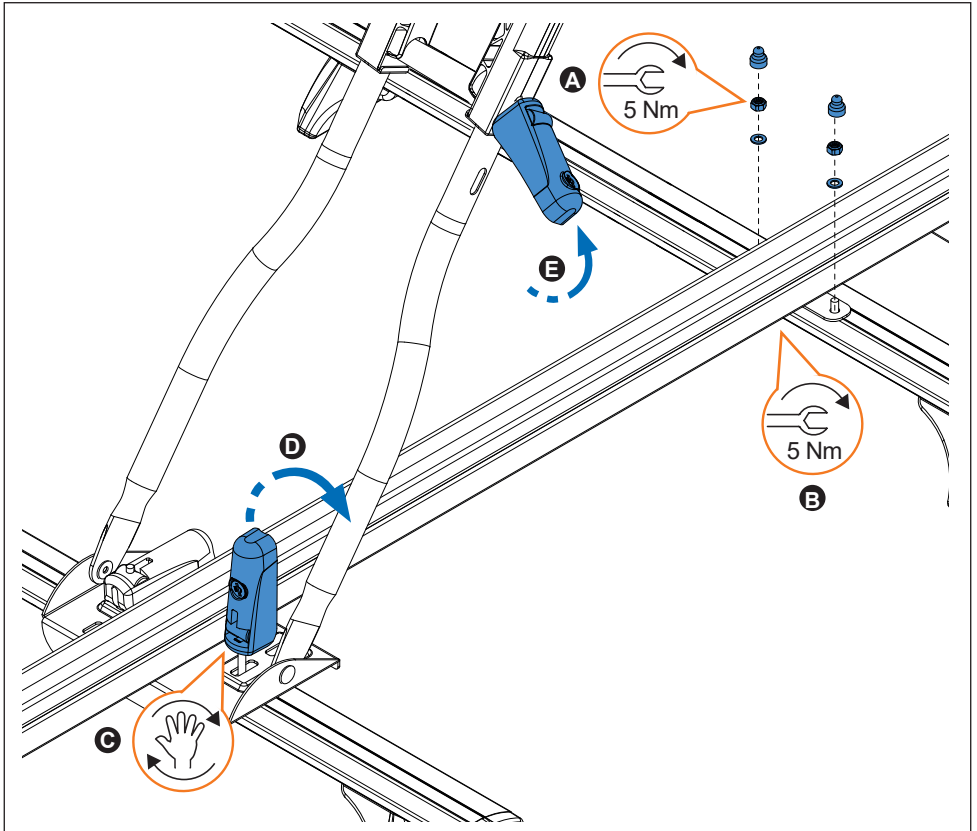

9. 

940-011
940-013

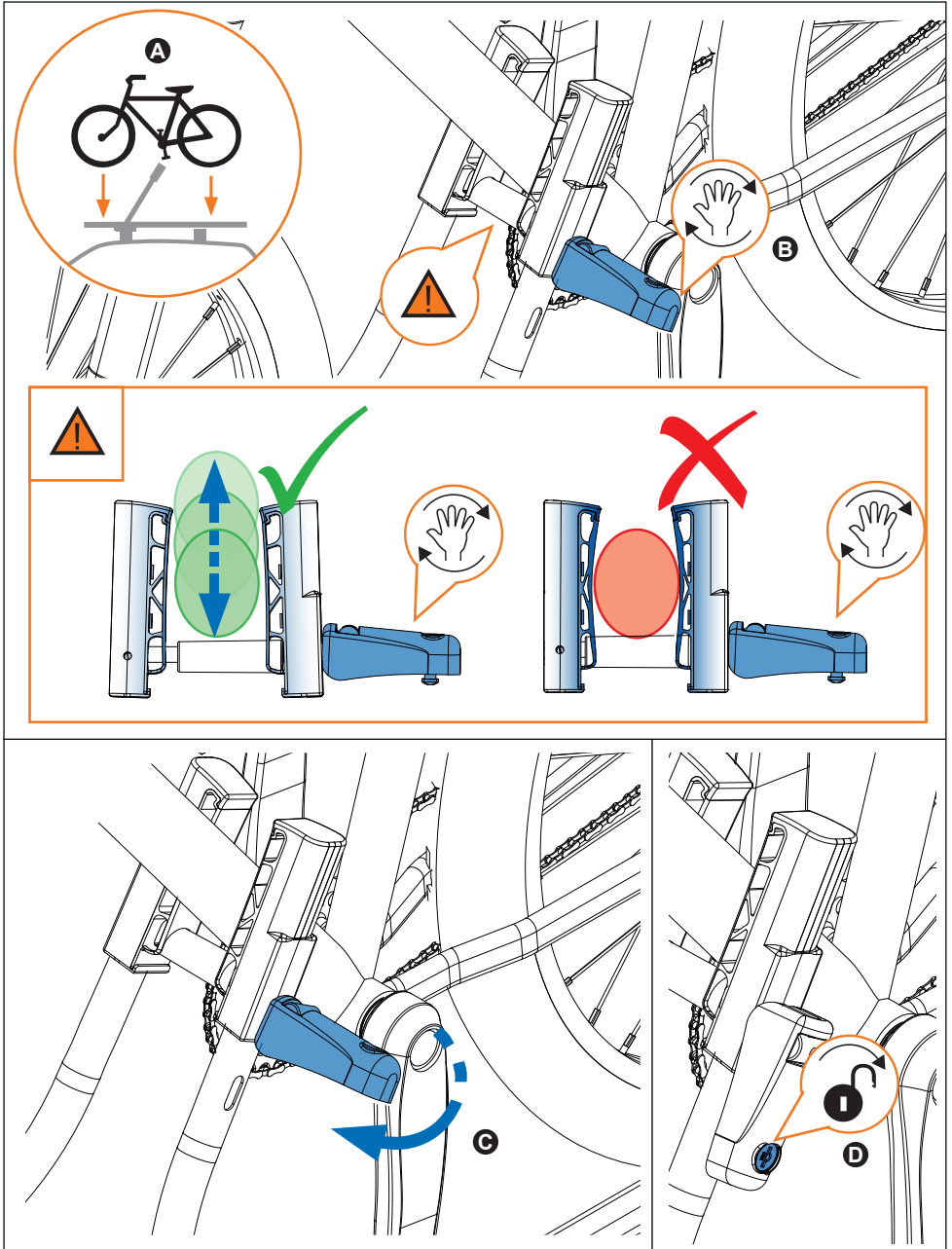

10.



940-011
940-013

