

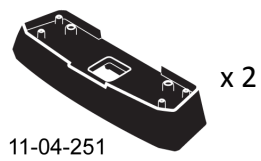

## GB Fitting Instructions for Basic Carrier

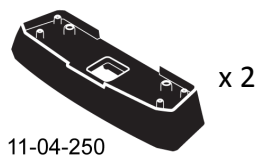

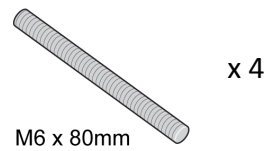
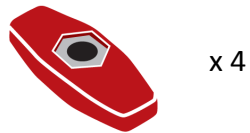
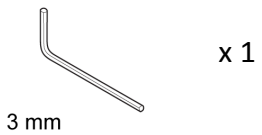
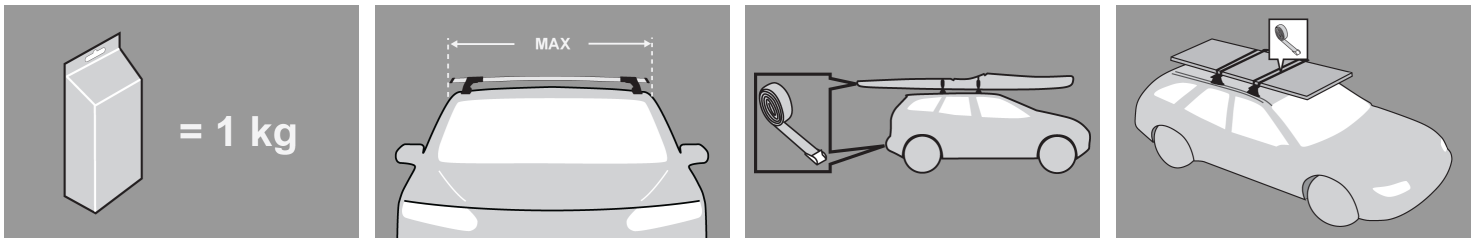
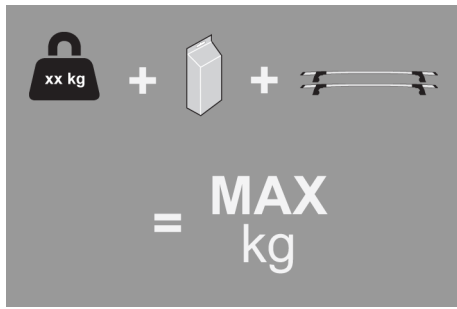

**MAX kg**  
 **W/P WHD**

**MAX kg**  
 **W/P WHD**

Ford  
 C Max , 5dr MPV 03-+  
 C Max , 5dr MPV 03-+  
 Jaguar  
 X-Type , 4dr Sedan 01-+  
 X-Type , 4dr Sedan 01-+

ZA	75	75
NZ	75	75
EU	75	75
AU	75	75

C Max , 5dr MPV 03-+  
 X-Type , 4dr Sedan 01-+  
 X-Type , 4dr Sedan 02-+

EU	75	75
NZ	75	75
ZA	75	75

## First Time Installation



- Remove parts from packaging and check contents. Contact your Prorack dealer if parts are missing or damaged.



- This kit fits type A, B, C and D.
- These instructions show type A crossbar fitted. They also apply to type B, C and D.



- Use keys to remove covers.



- Use hex screwdriver to reverse adjusting screw 10 turns.



- Press adjusting screw and pull crossbar legs out. Refer to the crossbar instructions for crossbar adjustment.
- Ensure each end of the crossbar is adjusted equally.

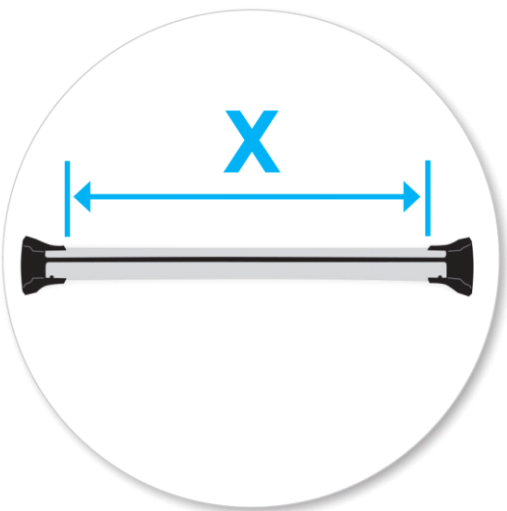

- Adjust crossbar in or out to suit vehicle. Refer to the crossbar instructions for crossbar adjustment.
- Please check the rear of this manual for information relating specifically to your vehicle.



- Tighten adjusting screw to 5 Nm.



- Remove clamp block by pressing backwards.



- Select plastic internal block (from fitting kit) and insert into foot.
- Repeat for all legs.



- Refer to the underside of the pad for the part number.

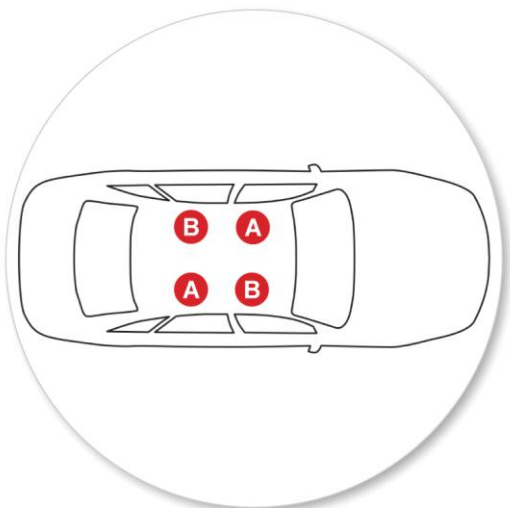

- Letters refer to the pad part numbers and position.
- Pad Part Number:  
A = 11-04-250  
B = 11-04-251



- Fit rubber pads (supplied with fitting kit) to foot. Pad may vary in shape to that shown.
- Note: Pads may be different to that shown.
- Make sure the pad fits into the holes underneath the foot.

## Fitment

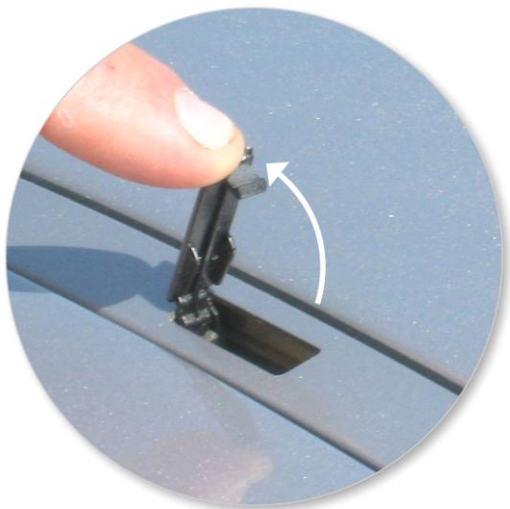

- Open or remove fixed-point covers.

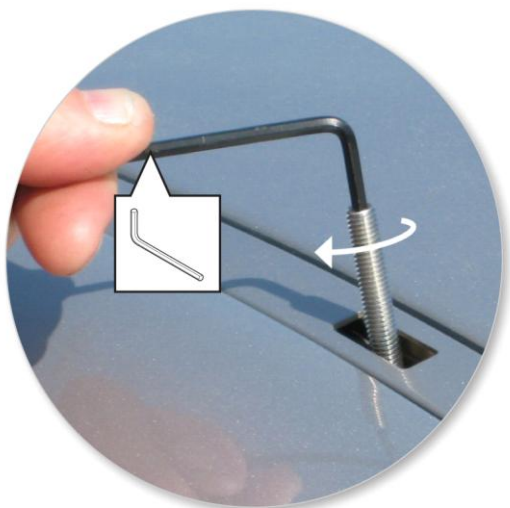

- Select grub screws and screw into the vehicle's fixed points.
- Do not over tighten.
- Repeat for all four positions.



- Place crossbar foot over grub screws.



- Tighten the red plastic knob. The side with the nut showing should be facing up.



- Ensure the red plastic knob is in the position shown when fully tightened.
- Repeat for all legs.



- Check crossbar is securely attached to the vehicle.
- Use keys to fit and lock covers



**CAUTION:**

**Recheck all fasteners immediately after a load is applied to the crossbars.**

**Regularly check screws are tight.**

---

## Maintenance

- Clean the car roof and surfaces of the product that will be in contact with the car roof.
- Follow the fitting instructions for fitting the product to your vehicle. Make sure all steps are carried out in order.
- Set crossbars a minimum distance of 700mm apart where no other distance is specified in the fitting instructions. This is especially important when carrying long loads.
- Check unit is securely attached whenever you refit it to the vehicle. If the unit feels loose, refer to the fitting instructions and readjust.
- Some sunroofs and radio antennae cannot be used when the product is fitted.
- Do not modify this product.
- Refer to the maximum permitted load capacity specified in the fitting instructions. Do not exceed the vehicle manufacturers roof load rating if it is lower than the maximum load capacity specified in the fitting instructions.
- Loads should not overhang the sides of the product and be evenly distributed with the lowest possible centre of gravity.
- Long loads should be secured with non-elastic straps to the front and rear of the vehicle.
- Objects with pointed ends (skis) should be carried with the pointed ends to the rear of the vehicle.
- Remove all loose or removable objects from the load prior to loading.
- Make sure all loads are securely fastened with non-elastic straps. Check regularly during longer journeys.

- A loaded roof rack system can alter the performance of your vehicle. Be especially aware of the effects of side winds, changing of direction, and braking performance. Avoid rapid acceleration and deceleration. Drive carefully.
  - Note that the total height of the vehicle increases when upright loads are carried.
  - Products should be locked during transport if they have locks fitted.
  - Check and replace worn out or defective parts.
  - Keep the product clean and maintained.
  - Never drive into a car wash with the roof rack system fitted.
  - Lubricate locks and adjusting screws at regular intervals.
  - Remove the products from the vehicle when not in use. Make sure all loose parts are stored safely.
- 

● Hubco Automotive Ltd  
P. O. Box 11017  
Christchurch  
NEW ZEALAND

[www.whispbar.com](http://www.whispbar.com)

---

**A = -**

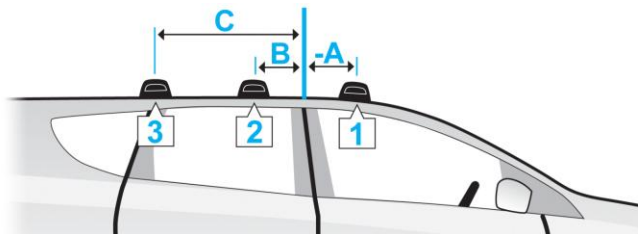

**A = +**

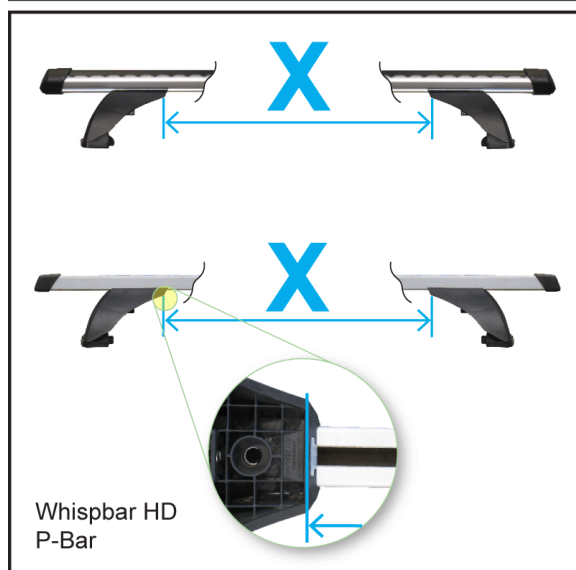
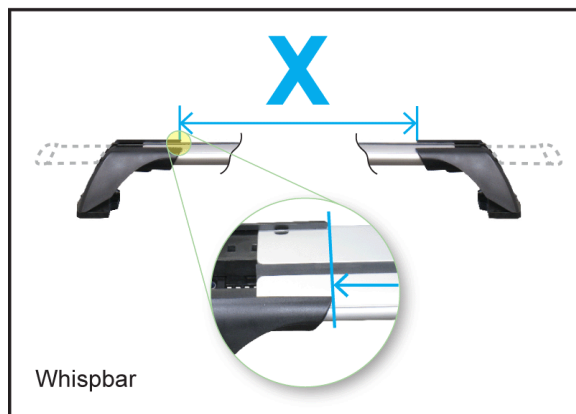
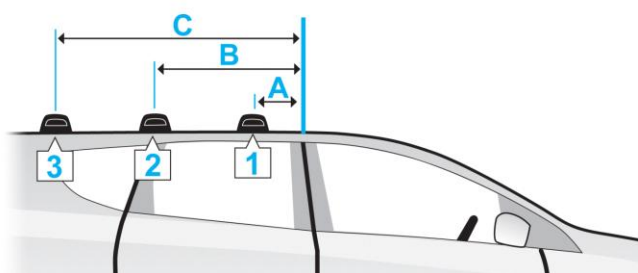

- Ford C Max , 5dr MPV 03-+ (EU)
- Ford C Max , 5dr MPV 03-+ (NZ)
- Ford C Max , 5dr MPV 03-+ (ZA)
- Jaguar X-Type , 4dr Sedan 01-+ (AU)
- Jaguar X-Type , 4dr Sedan 01-+ (EU)
- Jaguar X-Type , 4dr Sedan 01-+ (NZ)
- Jaguar X-Type , 4dr Sedan 02-+ (ZA)

	<b>X</b>					
	<b>A</b>	<b>B</b>	<b>C</b>	<b>1</b>	<b>2</b>	<b>3</b>
Ford C Max , 5dr MPV 03-+ (EU)	-25cm	43cm	-	904mm	845mm	-
Ford C Max , 5dr MPV 03-+ (NZ)	-9 13/16ths"	16 15/16ths"	-	35 9/16ths"	33 1/4"	-
Ford C Max , 5dr MPV 03-+ (ZA)	-25cm	43cm	-	904mm	845mm	-
Jaguar X-Type , 4dr Sedan 01-+ (AU)	-28.5cm	40cm	-	820mm	820mm	-
Jaguar X-Type , 4dr Sedan 01-+ (EU)	-11 1/4"	15 3/4"	-	32 5/16ths"	32 5/16ths"	-
Jaguar X-Type , 4dr Sedan 01-+ (NZ)	-28.5cm	40cm	-	820mm	820mm	-
Jaguar X-Type , 4dr Sedan 02-+ (ZA)	-11 1/4"	15 3/4"	-	32 5/16ths"	32 5/16ths"	-