

**GB** Fitting Instructions for Basic Carrier

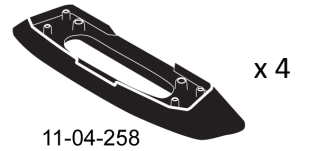

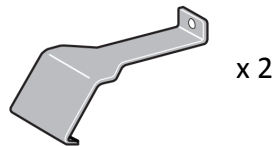

## MAX kg

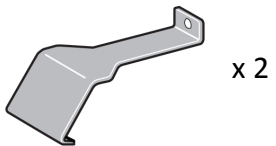
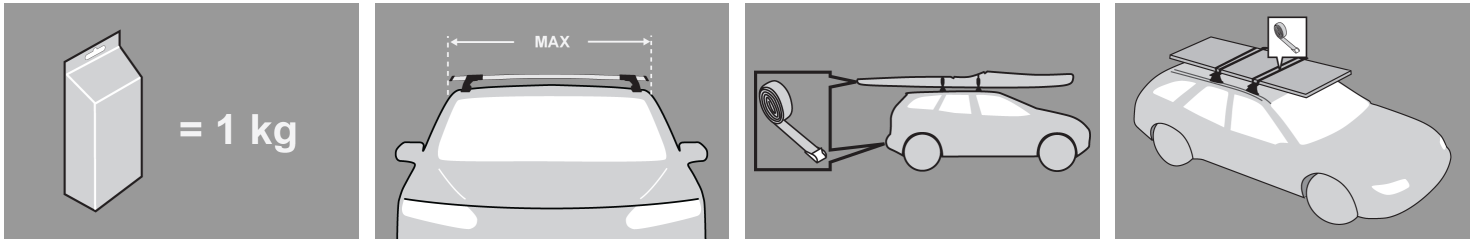
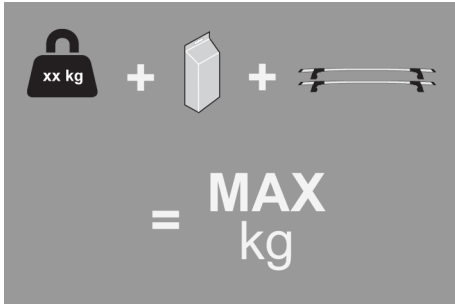

W/P WHD

## MAX kg



W/P WHD

### Chevrolet

Aveo , 4dr Sedan 07-+  
Aveo T250, 4dr Sedan 09-+  
Aveo T250, 5dr Hatch 09-+

ZA	75	75
EU	75	75
US	75	75

Aveo T250, 4dr Sedan 09-+  
Aveo T250, 5dr Hatch 09-+  
Aveo T250, 5dr Hatch 09-+

US	75	75
ZA	75	75
EU	75	75

### Holden

Barina TK, 4dr Sedan 06-+  
Barina TK, 5dr Hatch 06-+

NZ	75	75
NZ	75	75

Barina TK, 4dr Sedan 06-+  
Barina TK, 5dr Hatch 06-+

AU	75	75
AU	75	75

## First Time Installation



- Remove parts from packaging and check contents. Contact your Prorack dealer if parts are missing or damaged.



- This kit fits type A, B, C and D.
- These instructions show type A crossbar fitted. They also apply to type B, C and D.

**NOTE: Clamp images in these instructions may not be representative of the clamps in this kit**



- Use keys to remove covers.



- Use hex screwdriver to reverse adjusting screw 10 turns.



- Press adjusting screw and pull crossbar legs out. Refer to the crossbar instructions for crossbar adjustment.
- Ensure each end of the crossbar is adjusted equally.



- Remove locking screw.

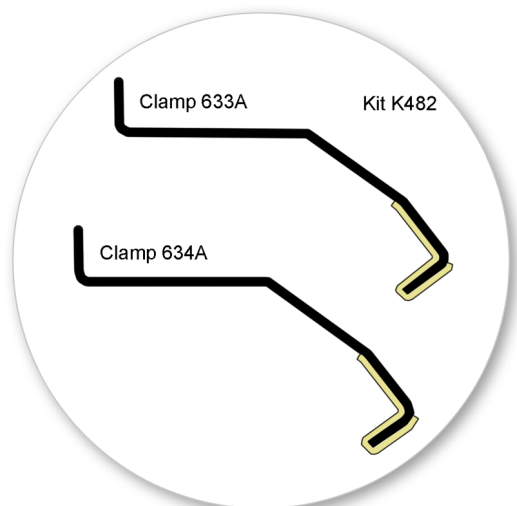

- Apply protective strip as shown.  
Trim if required.

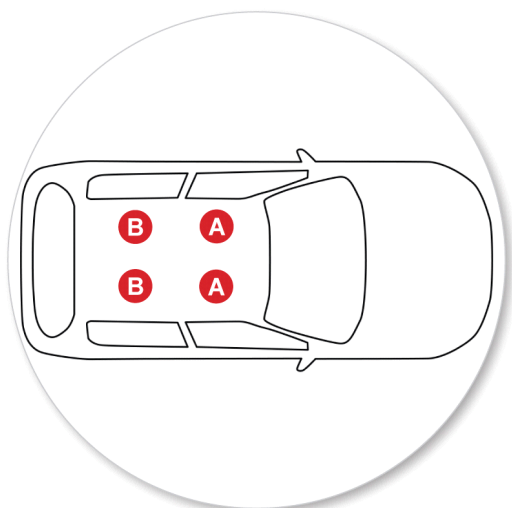

- It is important to put the clamps in the correct position on the vehicle.
- Letters refer to the part numbers stamped on clamps.
- Clamp Part Number:  
A = 633  
B = 634



- Attach clamp to each leg. NOTE; clamps may have labels showing their positions on the vehicle (For example; "Front Right").



- Refit locking screw so that it goes through the hole in the clamp. Do not begin to tighten the locking screw.



- Fit rubber pads (supplied with fitting kit) to foot. Pad may vary in shape to that shown.



- Make sure the pad fits into the holes underneath the foot.

## Fitment



- Place crossbar on vehicle. Minimum recommended spacing between the bars is 700mm (unless otherwise stated).
- Clamps directly to edge of roof under the doors
- Please check the rear of this manual for information relating specifically to your vehicle.



- Adjust the legs on the crossbar so that they are positioned equally from the ends of the crossbar, and the clamps engage firmly on the body work of the vehicle.



- Tighten adjusting screw to 5 Nm.

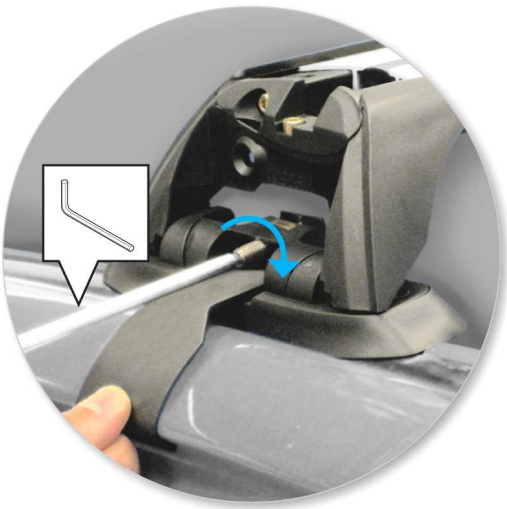

- Tighten locking screw on both legs evenly.



- Check crossbar is securely attached to the vehicle.





- Use keys to fit and lock covers

## CAUTION:

Recheck all fasteners immediately after a load is applied to the crossbars.

Regularly check screws are tight.

## Maintenance

- Clean the car roof and surfaces of the product that will be in contact with the car roof.
- Follow the fitting instructions for fitting the product to your vehicle. Make sure all steps are carried out in order.
- Set crossbars a minimum distance of 700mm apart where no other distance is specified in the fitting instructions. This is especially important when carrying long loads.
- Check unit is securely attached whenever you refit it to the vehicle. If the unit feels loose, refer to the fitting instructions and readjust.
- Some sunroofs and radio antennae cannot be used when the product is fitted.
- Do not modify this product.
- Refer to the maximum permitted load capacity specified in the fitting instructions. Do not exceed the vehicle manufacturers roof load rating if it is lower than the maximum load capacity specified in the fitting instructions.
- Loads should not overhang the sides of the product and be evenly distributed with the lowest possible centre of gravity.
- Long loads should be secured with non-elastic straps to the front and rear of the vehicle.
- Objects with pointed ends (skis) should be carried with the pointed ends to the rear of the vehicle.
- Remove all loose or removable objects from the load prior to loading.
- Make sure all loads are securely fastened with non-elastic straps. Check regularly during longer journeys.

- A loaded roof rack system can alter the performance of your vehicle. Be especially aware of the effects of side winds, changing of direction, and braking performance. Avoid rapid acceleration and deceleration. Drive carefully.
- Note that the total height of the vehicle increases when upright loads are carried.
- Products should be locked during transport if they have locks fitted.
- Check and replace worn out or defective parts.
- Keep the product clean and maintained.
- Never drive into a car wash with the roof rack system fitted.
- Lubricate locks and adjusting screws at regular intervals.
- Remove the products from the vehicle when not in use. Make sure all loose parts are stored safely.

---

● Hubco Automotive Ltd  
P. O. Box 11017  
Christchurch  
NEW ZEALAND

[www.whispbar.com](http://www.whispbar.com)

---

**A = -**

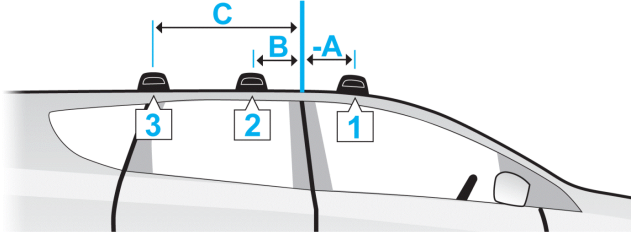

**A = +**

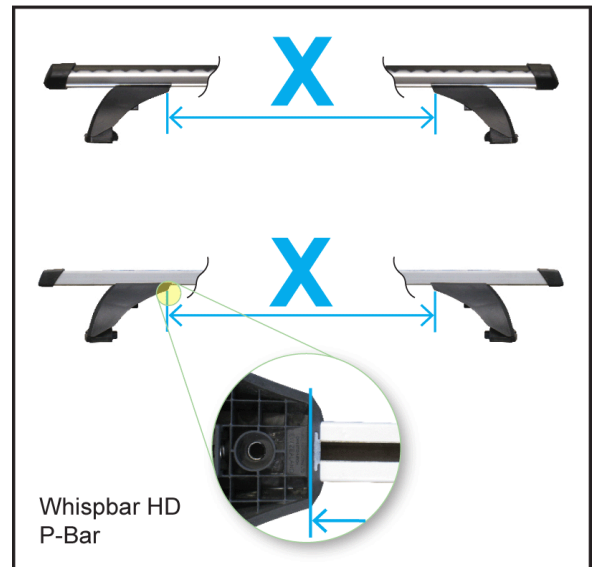
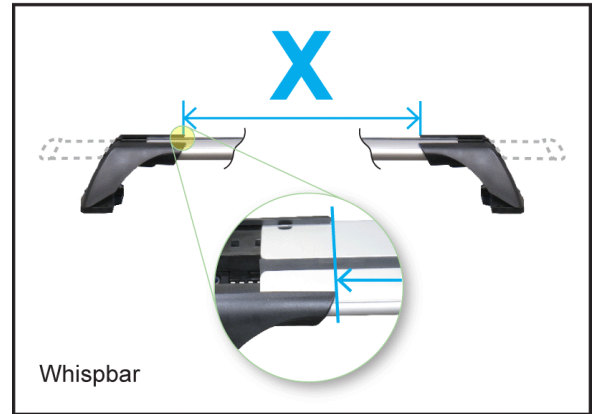
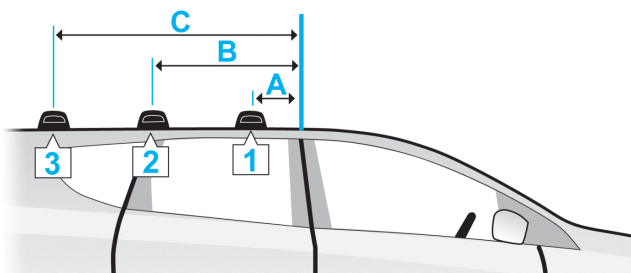

	<b>X</b>					
	<b>A</b>	<b>B</b>	<b>C</b>	<b>1</b>	<b>2</b>	<b>3</b>
Chevrolet Aveo , 4dr Sedan 07-+ (ZA)	-25cm -9 13/16ths"	35cm 13 3/4"	-	788mm 31 "	758mm 29 13/16ths"	-
Chevrolet Aveo T250, 4dr Sedan 09-+ (EU)	-25cm -9 13/16ths"	35cm 13 3/4"	-	788mm 31 "	758mm 29 13/16ths"	-
Chevrolet Aveo T250, 4dr Sedan 09-+ (US)	-25cm -9 13/16ths"	35cm 13 3/4"	-	788mm 31 "	758mm 29 13/16ths"	-
Chevrolet Aveo T250, 5dr Hatch 09-+ (EU)	-20cm -7 7/8"	50cm 19 11/16ths"	-	788mm 31 "	758mm 29 13/16ths"	-
Chevrolet Aveo T250, 5dr Hatch 09-+ (US)	-20cm -7 7/8"	50cm 19 11/16ths"	-	788mm 31 "	758mm 29 13/16ths"	-
Chevrolet Aveo T250, 5dr Hatch 09-+ (ZA)	-20cm -7 7/8"	50cm 19 11/16ths"	-	788mm 31 "	758mm 29 13/16ths"	-
Holden Barina TK, 4dr Sedan 06-+ (AU)	-25cm -9 13/16ths"	35cm 13 3/4"	-	788mm 31 "	758mm 29 13/16ths"	-
Holden Barina TK, 4dr Sedan 06-+ (NZ)	-25cm -9 13/16ths"	35cm 13 3/4"	-	788mm 31 "	758mm 29 13/16ths"	-
Holden Barina TK, 5dr Hatch 06-+ (AU)	-20cm -7 7/8"	50cm 19 11/16ths"	-	788mm 31 "	758mm 29 13/16ths"	-
Holden Barina TK, 5dr Hatch 06-+ (NZ)	-20cm -7 7/8"	50cm 19 11/16ths"	-	788mm 31 "	758mm 29 13/16ths"	-