

Kit 1009

MERCEDES BENZ 190 (W201), 4/5-dr, 83-93

MERCEDES BENZ 200-500 (W124), 4/5-dr, 85-95

MERCEDES BENZ C-Class (W202), 4/5-dr, 93-99

MERCEDES BENZ E-Class (W210), 4-dr Sedan, 95-01

**480R
754**

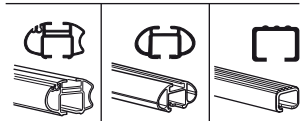
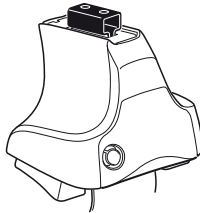

480

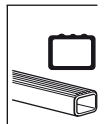
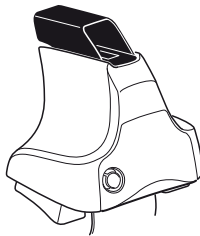

750

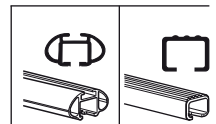
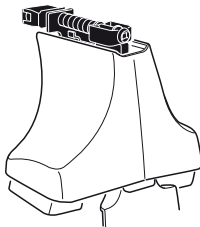

x2	x2	x2	x2	x2
x2	x2	x2	x2	x2
x2		x4	x4	
x4				

x4
 x4

x4
 x1

Kit



3



754

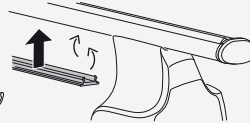
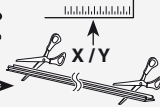

750

1

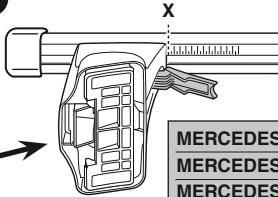
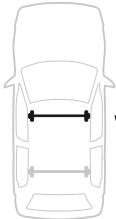

2

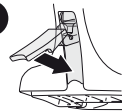

X

MERCEDES BENZ 190 (W201), 4/5-dr, 83-93	33
MERCEDES BENZ 200-500 (W124), 4/5-dr, 85-95	38
MERCEDES BENZ C-Class (W202), 4/5-dr, 93-99	35,5
MERCEDES BENZ E-Class (W210), 4-dr Sedan, 95-01	38

1

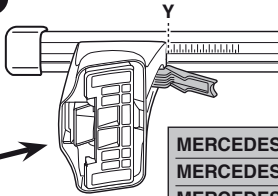

2

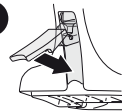

Y

MERCEDES BENZ 190 (W201), 4/5-dr, 83-93	31,5
MERCEDES BENZ 200-500 (W124), 4/5-dr, 85-95	36,5
MERCEDES BENZ C-Class (W202), 4/5-dr, 93-99	33
MERCEDES BENZ E-Class (W210), 4-dr Sedan, 95-01	38



480R



480

1

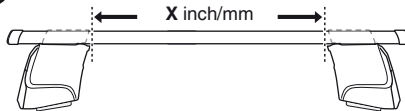
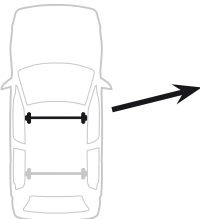

2

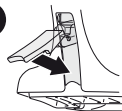

X inch X mm

MERCEDES BENZ 190 (W201), 4/5-dr, 83-93	38 ⁵ / ₈ "	981 mm
MERCEDES BENZ 200-500 (W124), 4/5-dr, 85-95	40 ⁵ / ₈ "	1031 mm
MERCEDES BENZ C-Class (W202), 4/5-dr, 93-99	39 ⁵ / ₈ "	1006 mm
MERCEDES BENZ E-Class (W210), 4-dr Sedan, 95-01	40 ⁵ / ₈ "	1031 mm

1

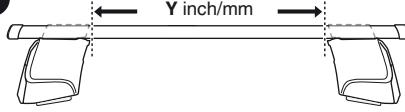
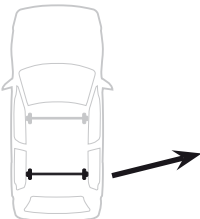

2

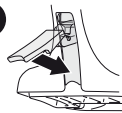

Y inch Y mm

MERCEDES BENZ 190 (W201), 4/5-dr, 83-93	38 "	966 mm
MERCEDES BENZ 200-500 (W124), 4/5-dr, 85-95	40 "	1016 mm
MERCEDES BENZ C-Class (W202), 4/5-dr, 93-99	38 ⁵ / ₈ "	981 mm
MERCEDES BENZ E-Class (W210), 4-dr Sedan, 95-01	40 ⁵ / ₈ "	1031 mm

4

MERCEDES BENZ 190 (W201), 4/5-dr, 83-93

MERCEDES BENZ 200-500 (W124), 4/5-dr, 85-95

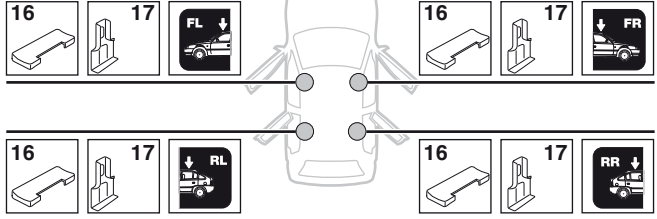

MERCEDES BENZ C-Class (W202), 4/5-dr, 93-99

MERCEDES BENZ E-Class (W210), 4-dr Sedan, 95-01

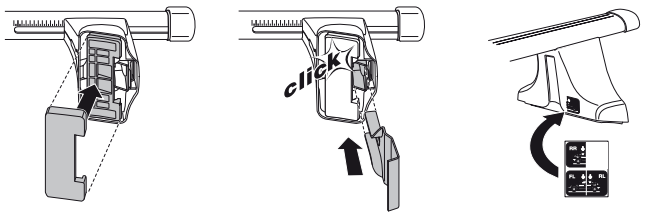
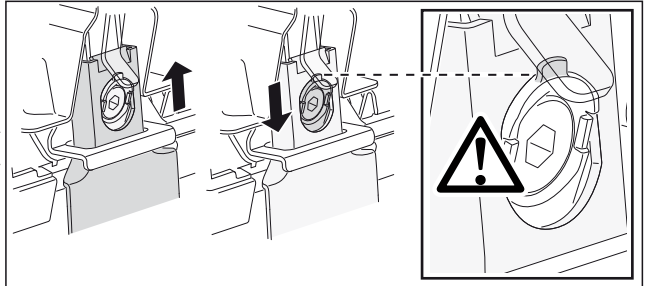
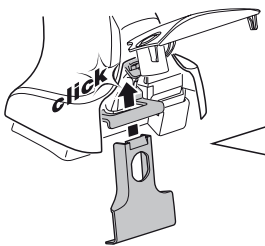
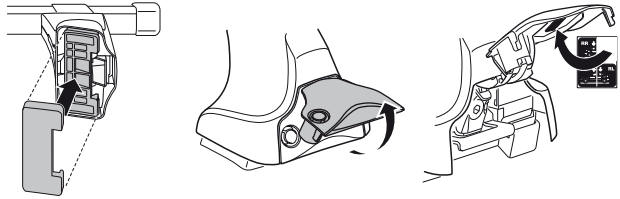
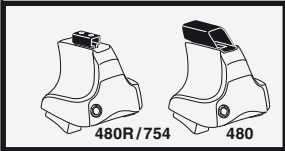
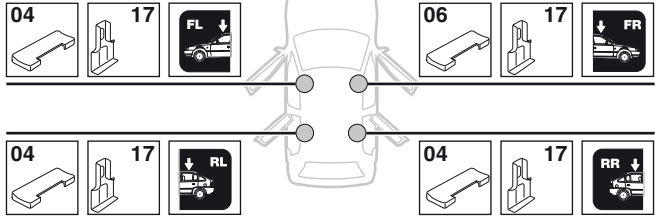

5

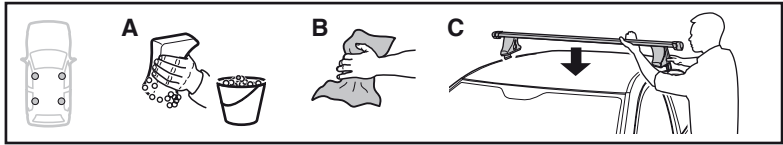

	X mm	Y mm	X inch	Y inch
MERCEDES BENZ 190 (W201), 4/5-dr, 83-93	-	-	-	-
MERCEDES BENZ 200-500 (W124), 4/5-dr, 85-95	-	-	-	-
MERCEDES BENZ C-Class (W202), 4/5-dr, 93-99	-	-	-	-
MERCEDES BENZ E-Class (W210), 4-dr Sedan, 95-01	210 mm	700 mm	8 1/4"	27 1/2"

MERCEDES BENZ 190 (W201), 4/5-dr, 83-93
 MERCEDES BENZ 200-500 (W124), 4/5-dr, 85-95
 MERCEDES BENZ C-Class (W202), 4/5-dr, 93-99

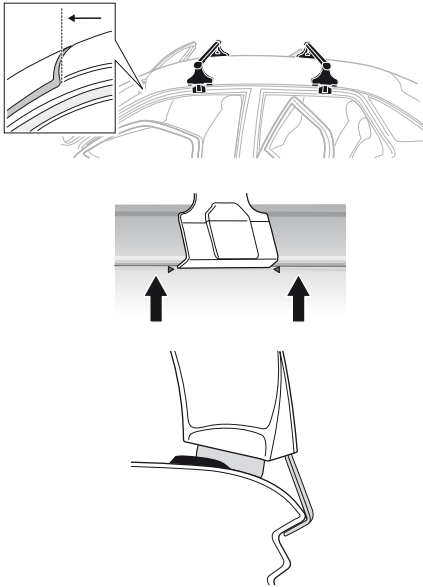

MERCEDES BENZ E-Class (W210), 4-dr Sedan, 95-01

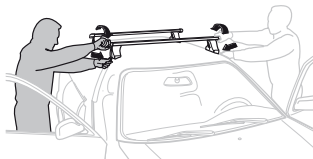
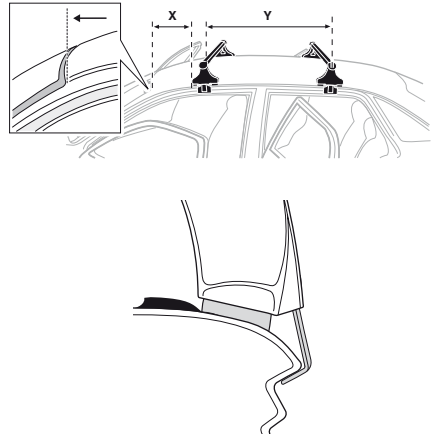

GB/US Tighten alternately
D Die Schrauben abwechselnd anziehen
F Serrer alternativement chaque côté
NL Afwisselend aan de linker- en de rechterkant aandraaien
I Alternare il serraggio delle viti
E Apretar alternativamente
PT Aperte alternadamente
S Dra åt växelvis
FIN Kierrä vuorotellen
EST Pinguldage vaheldumisi
LAT Pievelciēt pamišus
LIT Užsukinėkite pakaitomis
PL Śruby dokręcaj naprzemiennie
RU Затягивайте попеременно

CZ Pokrétla багаžníka dokręcaj dokręcaj naprzemiennie.
SK Dofahujte striedavo
SLO Privijajte izmenično.
HR Naizmjenično zategnute
HU Egyarástól függetlenül szorítandó
GR Σφιγγείτε εναλλάξ
TR Dönüşümlü sıkın

中文 交替拧紧

한국어 번갈아 가며 조이십시오.

日本語 交互に締め付けてください。

ไทย ขันในแบบสลับ

6



480R/754





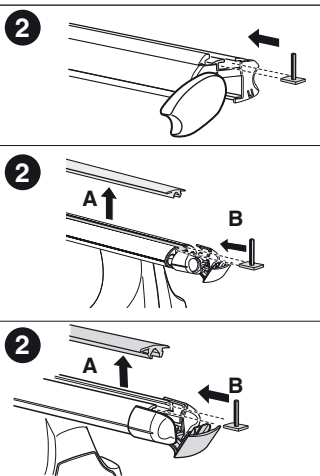
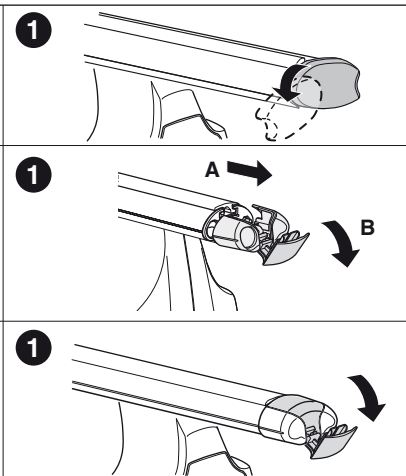
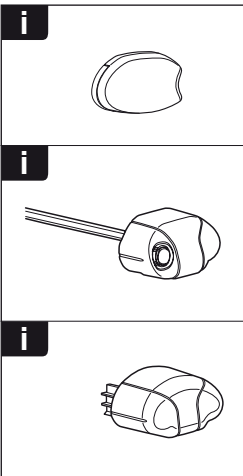
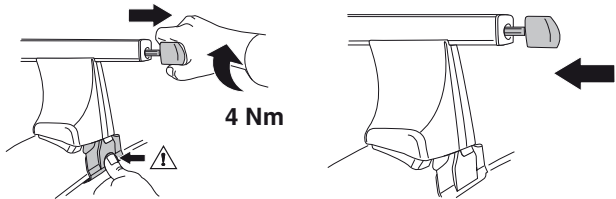
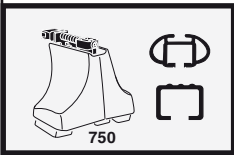

480





THULE
SWEDEN
**ONE
KEY
SYSTEM**



-  **544** (x4)
 -  **596** (x6)
 -  **588** (x8)
 -  **510** (x10)
 -  **452** (x12)
- NA
EUR
ASIA



WW ▶ Thule Sweden AB, Box 69, 330 33 Hillerstorp, SWEDEN
NA ▶ Thule Inc., 42 Silvermine Road, Seymour, Connecticut 06483, USA

info@thule.com
customer.service@thule.com

 www.thule.com