

Kit 1129

FORD Focus, 3-dr Hatchback, 98-03, 04

FORD Focus, 4-dr Sedan, 98-03, 04

FORD Focus, 5-dr Hatchback, 98-03, 04

FORD Focus, 5-dr Estate, 98-03, 04

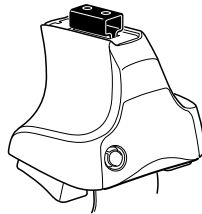

754 Rapid System
480R Rapid Traverse (North America)

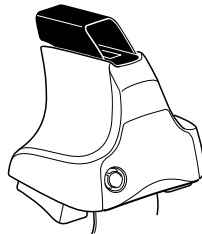
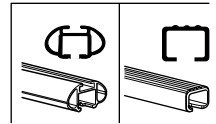

480 Traverse (North America)

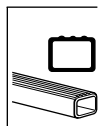

1

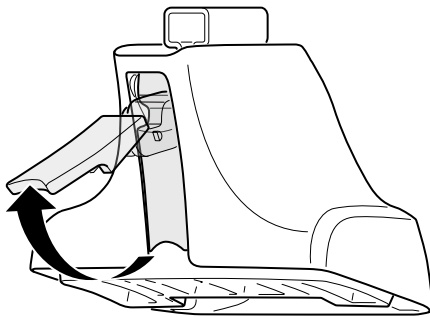

2

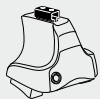

754 Rapid System
480R Rapid Traverse
(North America)

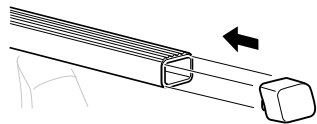
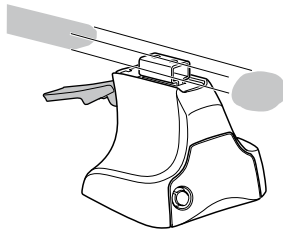

x4

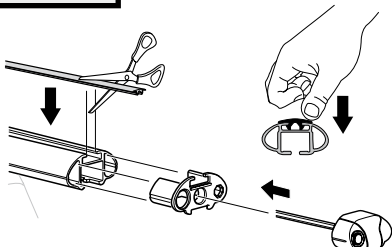
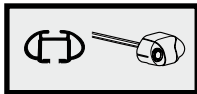

x4

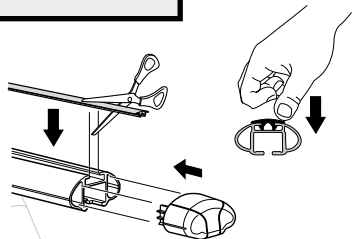
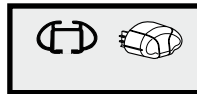

x4

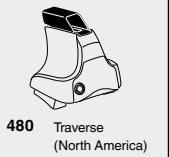

480 Traverse
(North America)

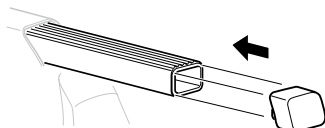
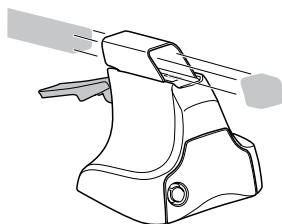

x4

3

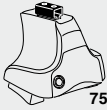

754 Rapid System

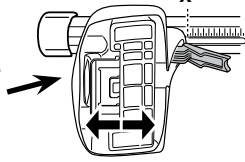
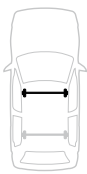

	X
FORD Focus, 3-dr Hatchback, 98-03, 04	33,5
FORD Focus, 4-dr Sedan, 98-03, 04	32,5
FORD Focus, 5-dr Hatchback, 98-03, 04	32,5
FORD Focus, 5-dr Estate, 98-03, 04	32

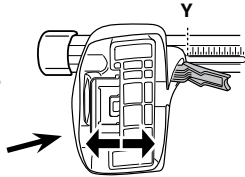

	Y
FORD Focus, 3-dr Hatchback, 98-03, 04	28
FORD Focus, 4-dr Sedan, 98-03, 04	30
FORD Focus, 5-dr Hatchback, 98-03, 04	29
FORD Focus, 5-dr Estate, 98-03, 04	28,5

3



480R Rapid Traverse



480 Traverse



(North America)

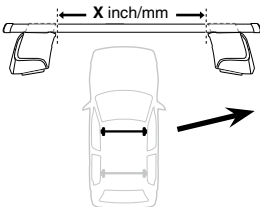

	X inch	X mm
FORD Focus, 3-dr Hatchback, 98-03, 04	38 ⁷/₈ "	986 mm
FORD Focus, 4-dr Sedan, 98-03, 04	38 ³/₈ "	976 mm
FORD Focus, 5-dr Hatchback, 98-03, 04	38 ³/₈ "	976 mm
FORD Focus, 5-dr Estate, 98-03, 04	38 ¹/₄ "	971 mm

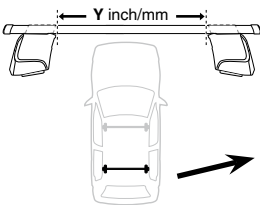

	Y inch	Y mm
FORD Focus, 3-dr Hatchback, 98-03, 04	36 ⁵/₈ "	931 mm
FORD Focus, 4-dr Sedan, 98-03, 04	37 ¹/₂ "	951 mm
FORD Focus, 5-dr Hatchback, 98-03, 04	37 "	941 mm
FORD Focus, 5-dr Estate, 98-03, 04	36 ⁷/₈ "	936 mm

4

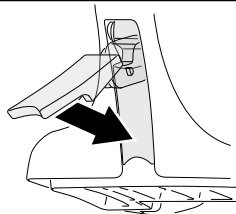

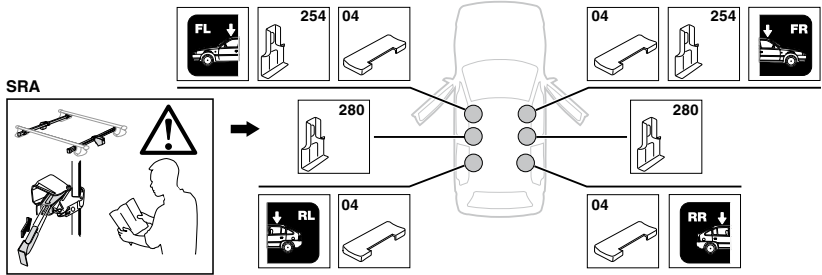
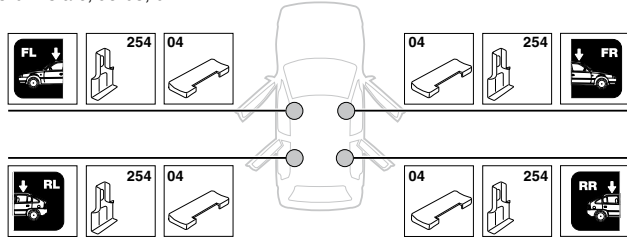
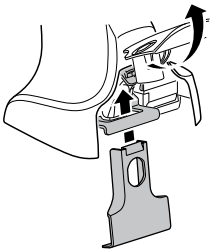
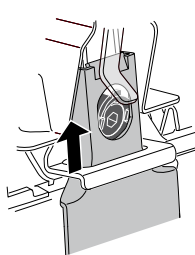
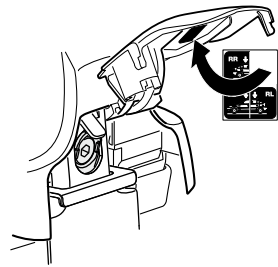
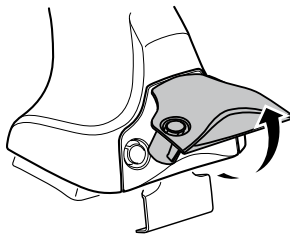
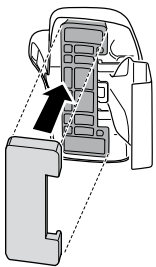
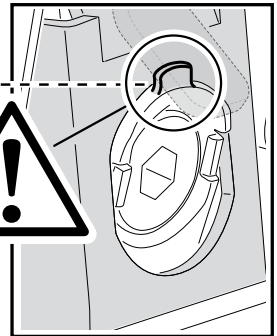
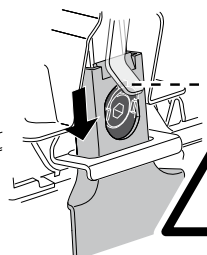
5**FORD Focus, 3-dr Hatchback, 98-03, 04****FORD Focus, 4-dr Sedan, 98-03, 04****FORD Focus, 5-dr Hatchback, 98-03, 04****FORD Focus, 5-dr Estate, 98-03, 04****A****B****C**

6

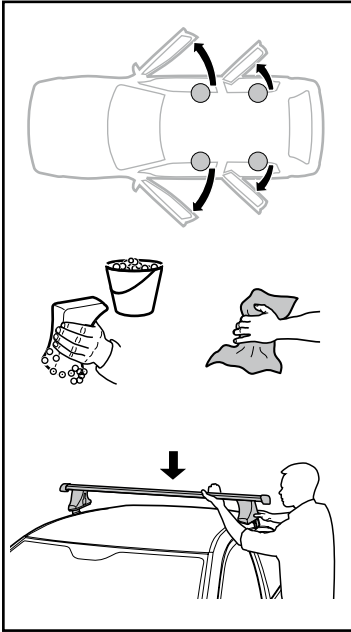

i

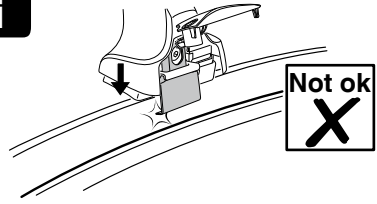

A

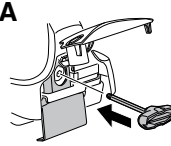

B

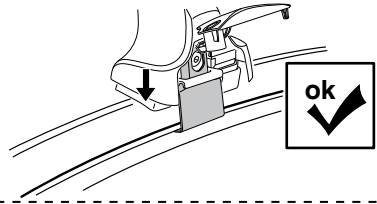
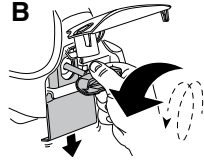

SRA

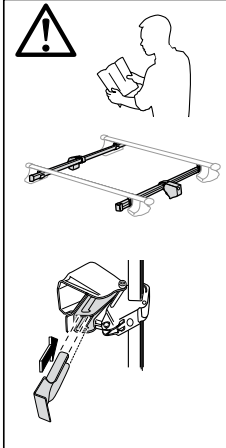

FORD Focus, 3-dr Hatchback, 98-03, 04

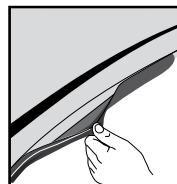
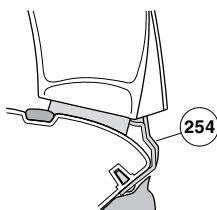
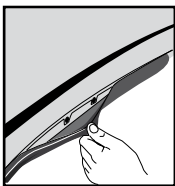
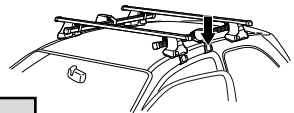
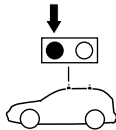
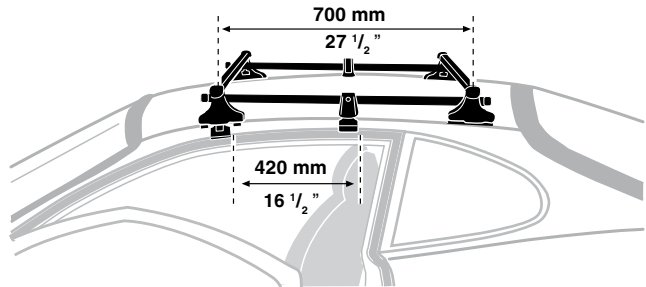

6

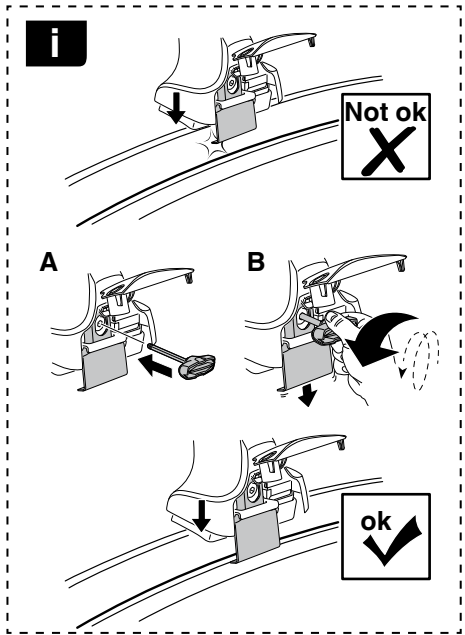
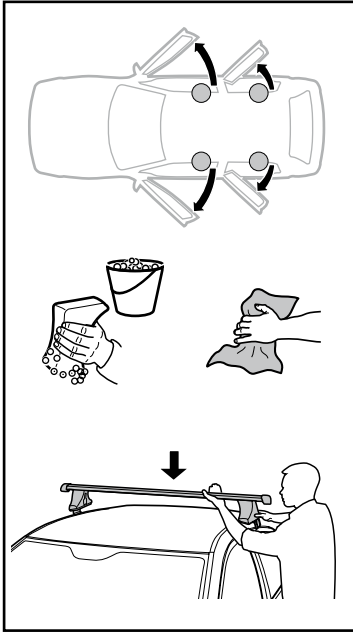

	↓	↓
FORD Focus, 4-dr Sedan, 98-03, 04	● ○	○ ●
FORD Focus, 5-dr Hatchback, 98-03, 04	○ ●	○ ●
FORD Focus, 5-dr Estate, 98-03, 04	○ ●	○ ●

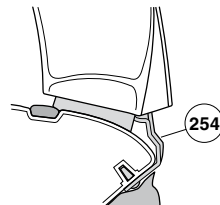
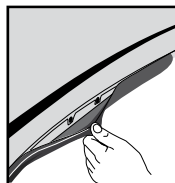
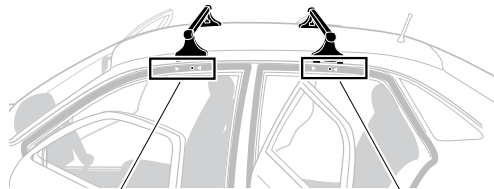
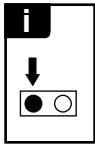

7

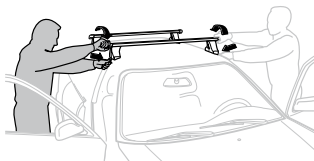

GB/US	Tighten alternately
D	Die Schrauben abwechselnd anziehen
F	Serrer alternativement chaque côté
NL	Afwisselend aan de linker- en de rechterkant aandraaien
I	Alternare il serraggio delle viti
E	Apretar alternativamente
PT	Aperte alternadamente
S	Dra åt växelvis
FIN	Kierrä vuorotellen
EST	Pinguldage vaheldumisi
LAT	Pielveiciet pamišus
LIT	Užsukinėkite pakaitomis
PL	Śruby dokręcaj naprzemiennie
RU	Загтягивайте попеременно

CZ	Pokręťta bagażnika dokręcaj dokręcaj naprzemiennie.
SK	Dofahajte striedavo
SLO	Privijajte izmenično.
HR	Naizmjenočno zategnite
HU	Egymástól függetlenül szorítandó
GR	Σφιγίγες εναλλάξ
TR	Dönüşümlü sıkın

中文 交替拧紧

한국어 번갈아 가며 조이십시오.

日本語 交互に締め付けてください。

ไทย ชันในแบบสลับ

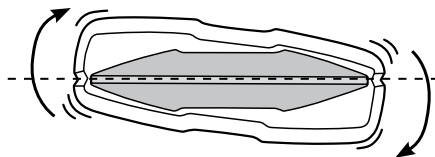
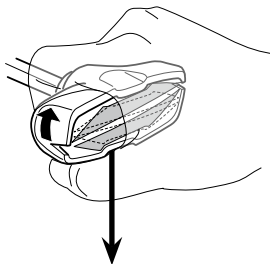
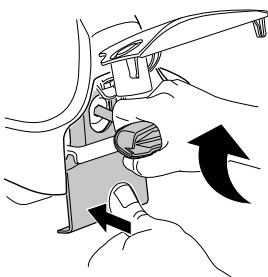
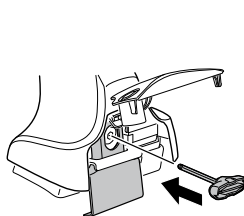

≈ 3 Nm

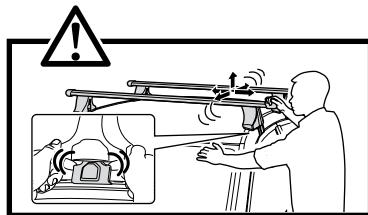
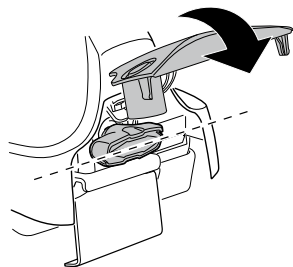

8



x1
17 mm

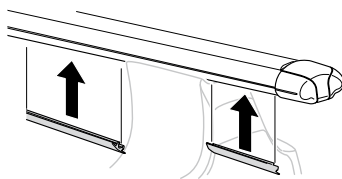

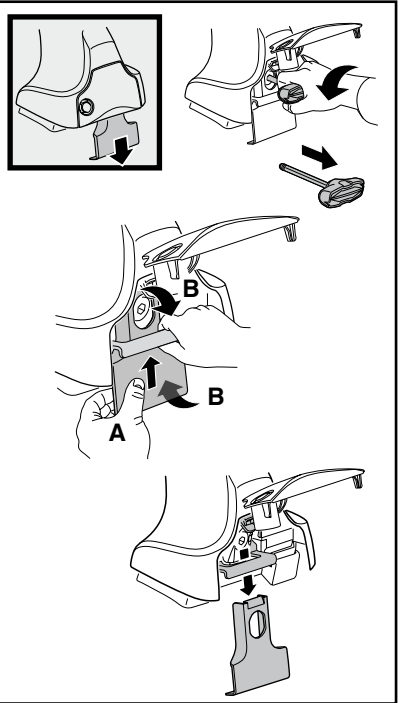
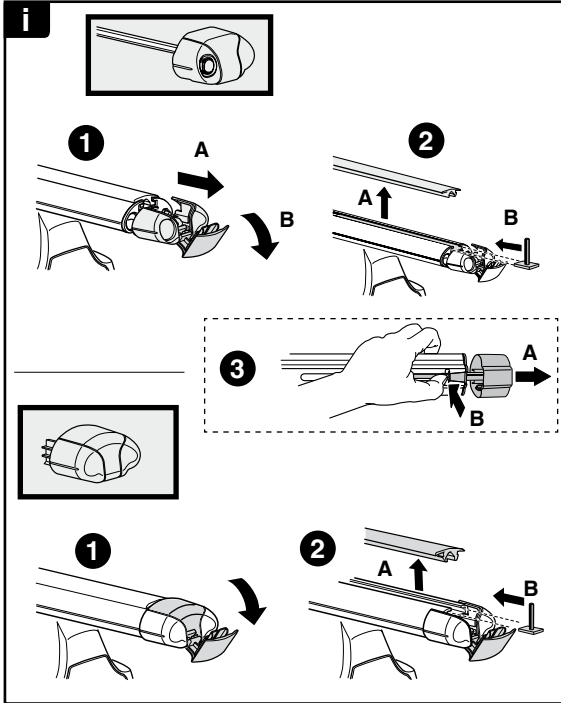
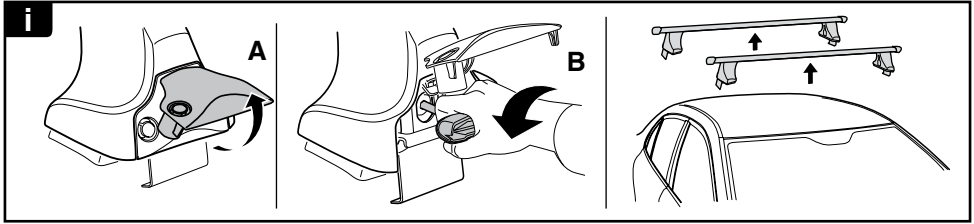

THULE
SWEDEN
**ONE
KEY
SYSTEM**

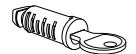
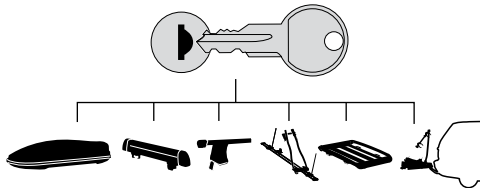

544 (x4)

596 (x6)

588 (x8)

NA **510** (x10)

EUR **452** (x12)

ASIA

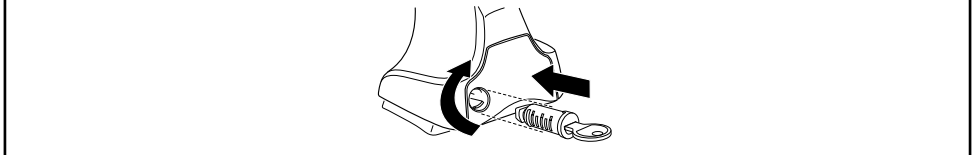

WW ▶ Thule Sweden AB, Box 69, 330 33 Hillerstorp, SWEDEN
NA ▶ Thule Inc., 42 Silvermine Road, Seymour, Connecticut 06483, USA

info@thule.com
customer.service@thule.com

www.thule.com

503-1129-03