

Kit 1167

OPEL Agila, 5-dr MPV, 00-07

SUZUKI Wagon R, 3-dr MPV, 99-02

SUZUKI Wagon R, 5-dr MPV, 99-02

SUZUKI Wagon R+, 5-dr MPV, 99-07

480R
754

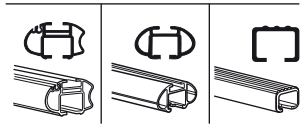
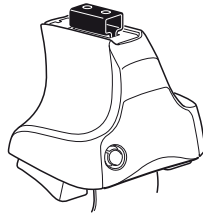

480

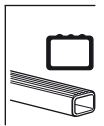
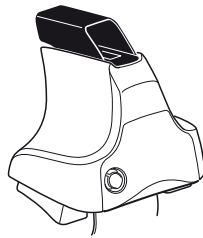

750

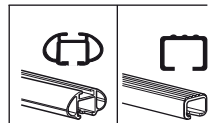
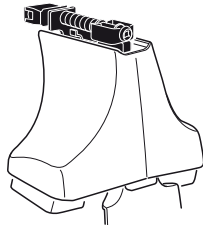

THULE[®]
SWEDEN

xx kg / xx lbs + 7 kg / 15,4 lbs = Max. 50 kg / Max. 110 lbs
 3 kg / 6,6 lbs

80 km/h 50 Mph 130 km/h 80 Mph
 40 km/h 25 Mph 0 km/h Mph

+ Kit XXXX

x1 x4 x4 x4 x4
 480R/754

x1 x4 x4 x4
 480

x1 x4 x4
 750

x2	x2	x2	x2	x2
x2	x2	x2	x2	x2
x2	x2	x2	x2	x2
x4	x4	x4	x4	x4

317 x4 07 x4 x1

Kit



3

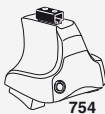

754

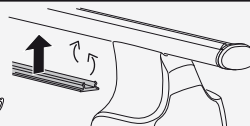
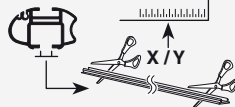

750

1

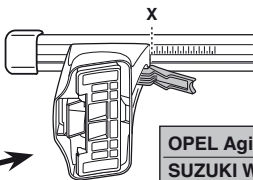
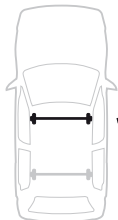

2

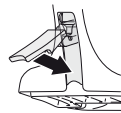

	X
OPEL Agila, 5-dr MPV, 00-07	35,5
SUZUKI Wagon R, 3-dr MPV, 99-02	23
SUZUKI Wagon R, 5-dr MPV, 99-02	23
SUZUKI Wagon R+, 5-dr MPV, 99-07	35,5

1

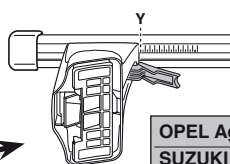

2

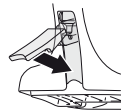

	Y
OPEL Agila, 5-dr MPV, 00-07	33,5
SUZUKI Wagon R, 3-dr MPV, 99-02	20,5
SUZUKI Wagon R, 5-dr MPV, 99-02	20,5
SUZUKI Wagon R+, 5-dr MPV, 99-07	33,5

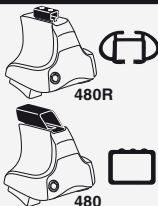

480R

480

1

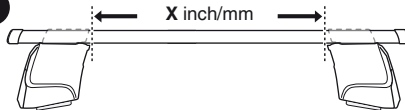

2

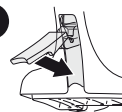

	X inch	X mm
OPEL Agila, 5-dr MPV, 00-07	39 ⁵ / ₈ ''	1006 mm
SUZUKI Wagon R, 3-dr MPV, 99-02	34 ⁵ / ₈ ''	881 mm
SUZUKI Wagon R, 5-dr MPV, 99-02	34 ⁵ / ₈ ''	881 mm
SUZUKI Wagon R+, 5-dr MPV, 99-07	39 ⁵ / ₈ ''	1006 mm

1

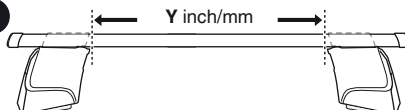

2

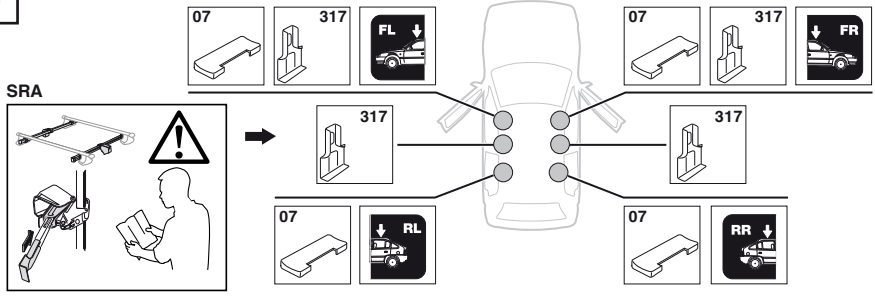
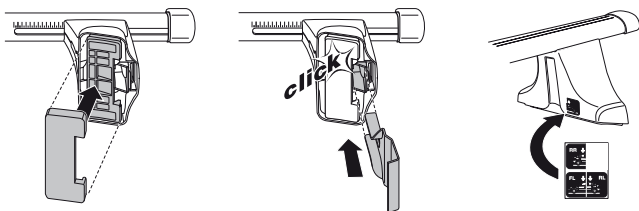
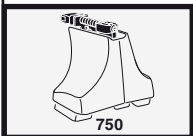
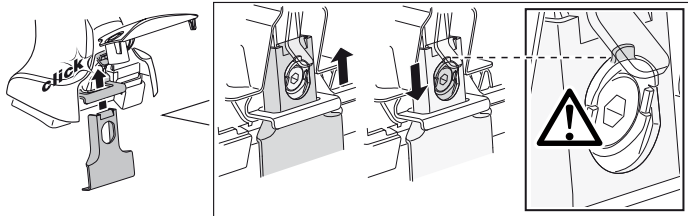
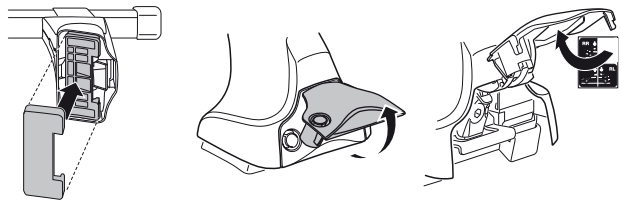
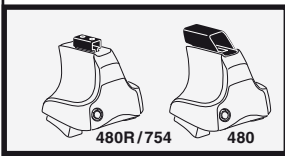
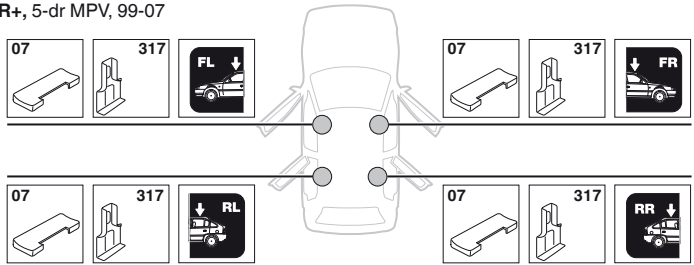

	Y inch	Y mm
OPEL Agila, 5-dr MPV, 00-07	38 ⁷ / ₈ ''	986 mm
SUZUKI Wagon R, 3-dr MPV, 99-02	33 ³ / ₄ ''	856 mm
SUZUKI Wagon R, 5-dr MPV, 99-02	33 ³ / ₄ ''	856 mm
SUZUKI Wagon R+, 5-dr MPV, 99-07	38 ⁷ / ₈ ''	986 mm

4**SUZUKI Wagon R, 3-dr MPV, 99-02****OPEL Agila, 5-dr MPV, 00-07****SUZUKI Wagon R, 5-dr MPV, 99-02****SUZUKI Wagon R+, 5-dr MPV, 99-07**

5

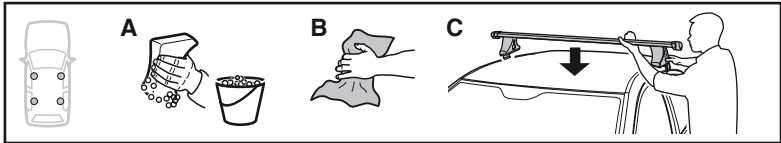

	X mm	Y mm	X inch	Y inch
OPEL Agila, 5-dr MPV, 00-07	310 mm	700 mm	12 1/4"	27 1/2"
SUZUKI Wagon R, 3-dr MPV, 99-02	260 mm	700 mm	10 1/4"	27 1/2"
SUZUKI Wagon R, 5-dr MPV, 99-02	260 mm	700 mm	10 1/4"	27 1/2"
SUZUKI Wagon R+, 5-dr MPV, 99-07	310 mm	700 mm	12 1/4"	27 1/2"

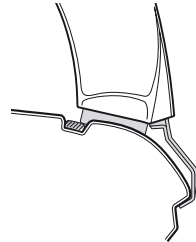
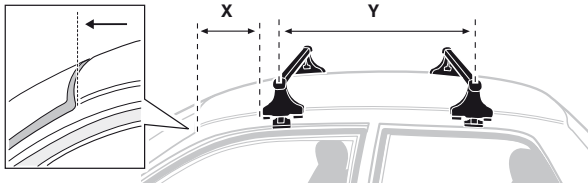

SUZUKI Wagon R, 3-dr MPV, 99-02

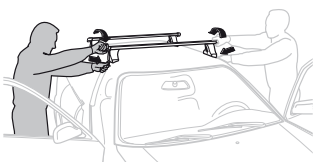
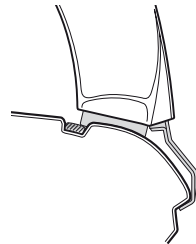
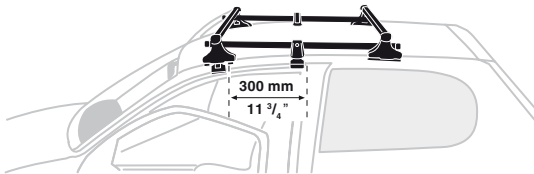

- GB/US** Tighten alternately
- D** Die Schrauben abwechselnd anziehen
- F** Serrer alternativement chaque côté
- NL** Afwisselend aan de linker- en de rechterkant aandraaien
- I** Alternare il serraggio delle viti
- E** Apretar alternativamente
- PT** Aperte alternadamente
- S** Dra åt växelvis
- FIN** Kierrä vuorotellen
- EST** Pinguldage vaheldumisi
- LAT** Pievelciēt pamišus
- LIT** Užsukinėkite pakaitomis
- PL** Śruby dokręcaj naprzemiennie
- RU** Затягивайте попеременно

- CZ** Pokrétla багажника dokręcaj dokręcaj naprzemiennie.
- SK** Dofahujte striedavo
- SLO** Privijajte izmenično.
- HR** Naizmjenično zategnite
- HU** Egymástól függetlenül szorítandó
- GR** Σφιγγετε εναλλάξ
- TR** Dönüşümlü sıkın
- 中文** 交替拧紧
- 한국어** 번갈아 가며 조이십시오.
- 日本語** 交互に締め付けてください。
- ไทย** ชันในแบบสลับ

6



480R/754



480

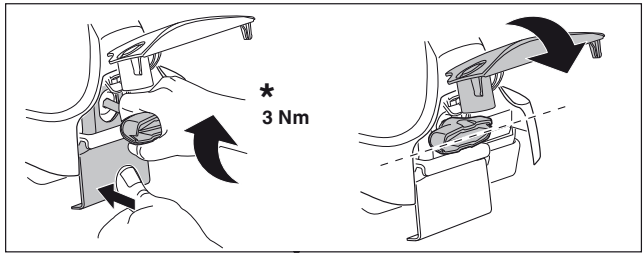
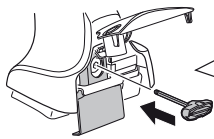

*
3 Nm



*



*
≈ 3 Nm

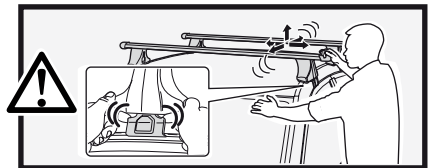

750

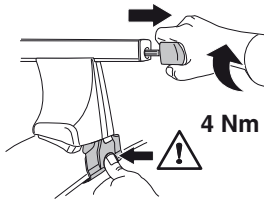

4 Nm

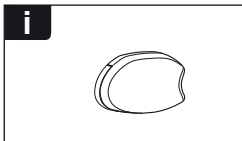
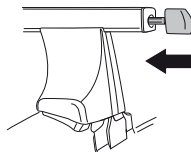

i

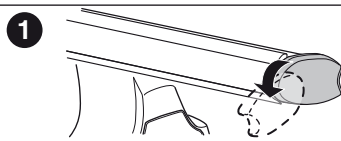

1

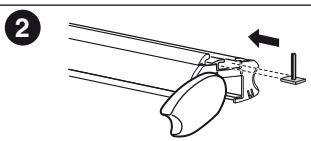

2

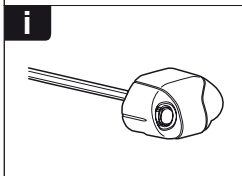

i

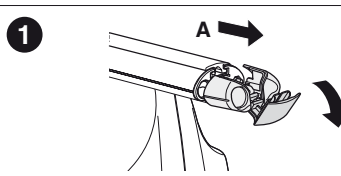

1

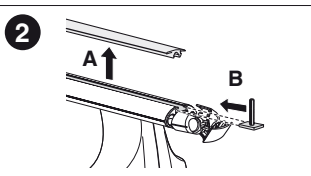

2

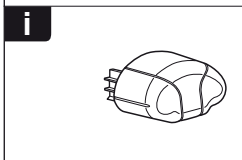

i

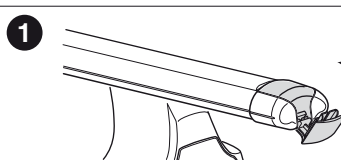

1

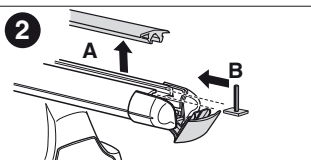

2

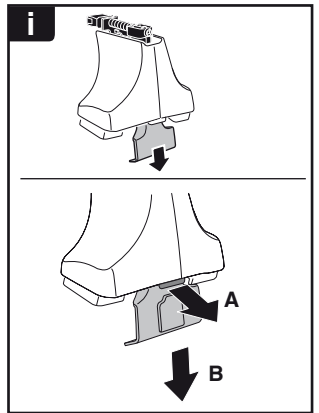

THULE
SWEDEN
**ONE
KEY
SYSTEM**



		(x4)
		(x6)
		(x8)
NA		(x10)
EUR		(x12)
ASIA		(x12)



WW ▶ Thule Sweden AB, Box 69, 330 33 Hillerstorp, SWEDEN
NA ▶ Thule Inc., 42 Silvermine Road, Seymour, Connecticut 06483, USA

info@thule.com
customer.service@thule.com

www.thule.com