

Kit 1387

VOLVO S60, 4-dr Sedan, 01-04, 05- / *01-09

*North America

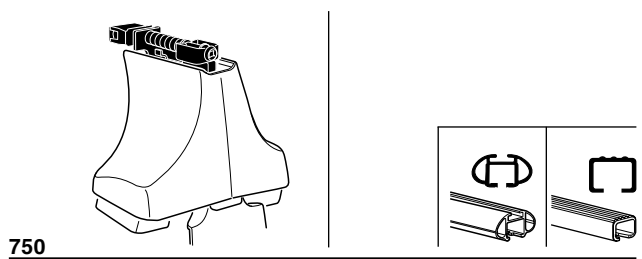
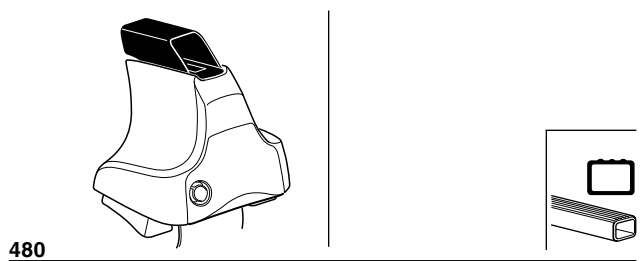
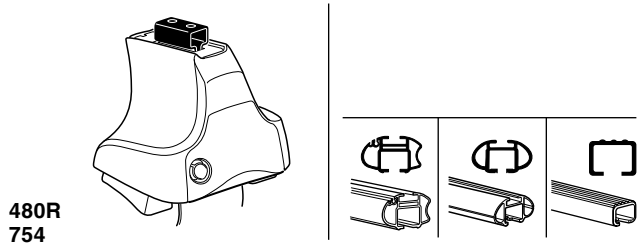

- 1x [Long metal bar]
- 2x [Bracket]
- 2x [Bracket]
- 2x [Bracket]
- 2x [Bracket]
- 4x [Bracket]
- 2x [Bracket]
- 2x [Bracket]
- 2x [Bracket]
- 2x [Bracket]
- 2x [Bracket]
- 2x [Bracket]
- 2x [Bracket]
- 4x [Bracket]
- 4x [Bracket]

- 2x [Foot 187]
- 2x [Foot 189]
- 1x [Foot 692]
- 1x [Foot 693]
- 1x [Foot 694]
- 1x [Foot 695]

Kit

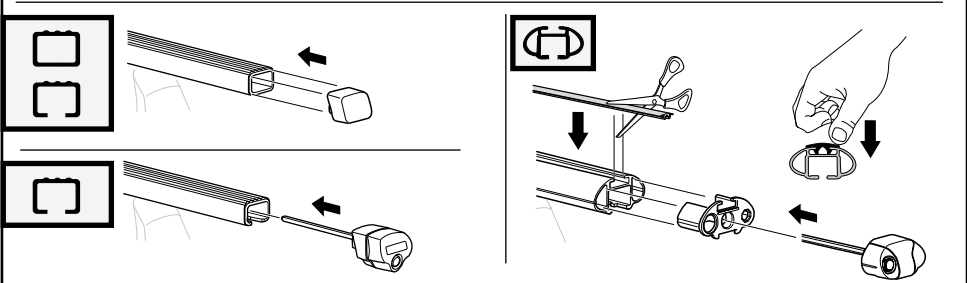
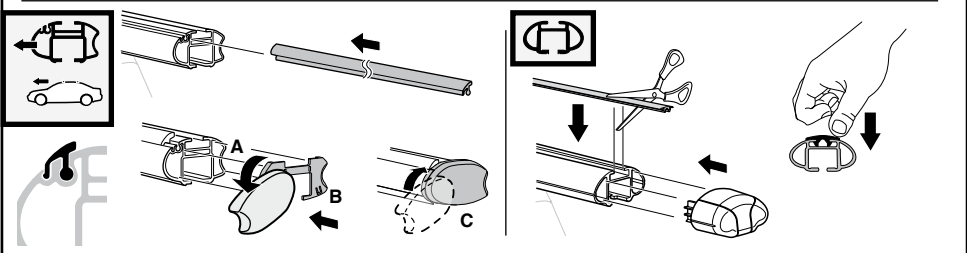
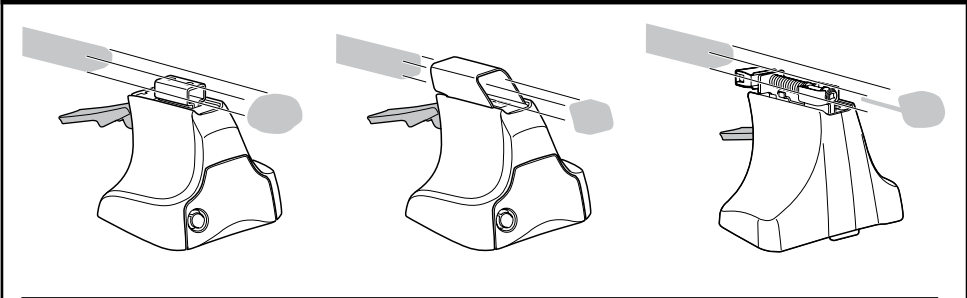

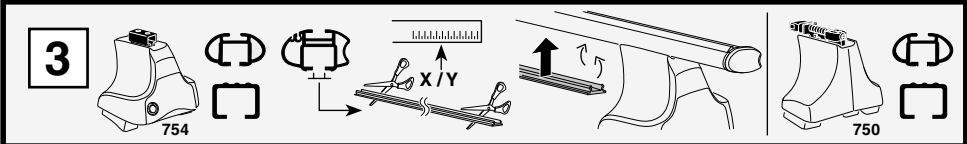

1

2

VOLVO S60, 4-dr Sedan, 01-04, 05- / *01-09	X
	40

1

2

VOLVO S60, 4-dr Sedan, 01-04, 05- / *01-09	Y
	37

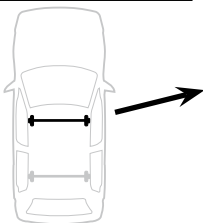
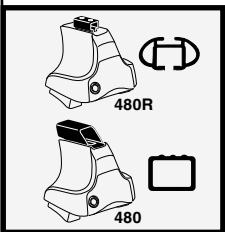

1

2

VOLVO S60, 4-dr Sedan, 01-04, 05- / *01-09	X inch	X mm
	41 3/8"	1051 mm

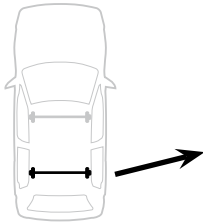

1

2

VOLVO S60, 4-dr Sedan, 01-04, 05- / *01-09	Y inch	Y mm
	40 1/4"	1021 mm

4

VOLVO S60, 4-dr Sedan, 01-04, 05- / *01-09

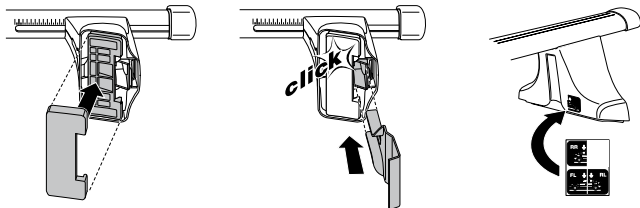
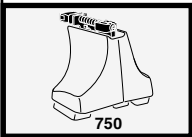
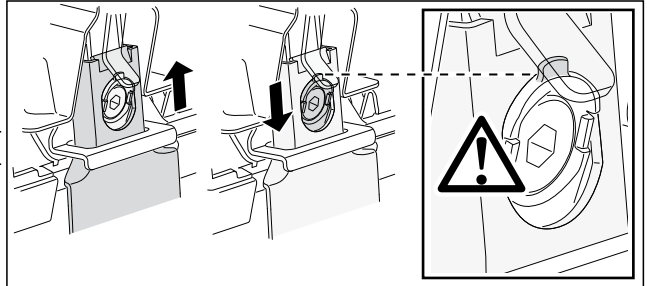
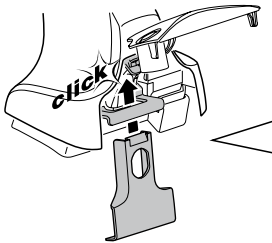
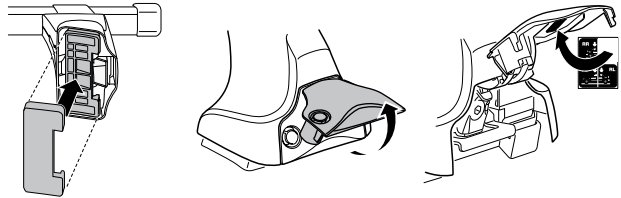
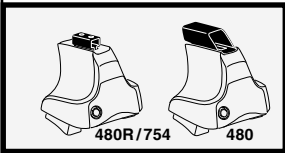
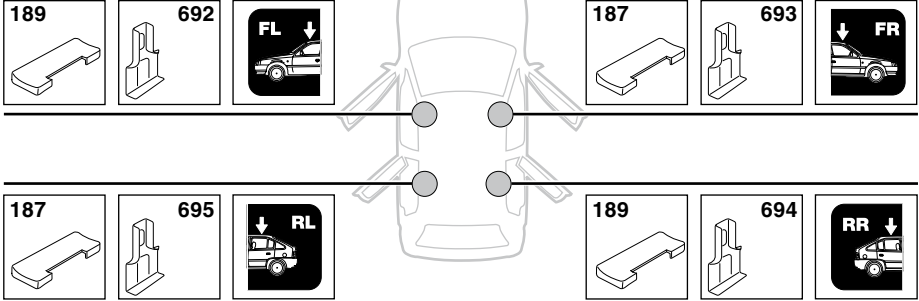

5

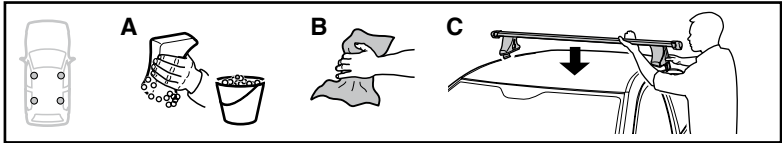

	X mm	Y mm	X inch	Y inch
VOLVO S60, 4-dr Sedan, 01-04, 05- / *01-09	245 mm	650 mm	9 5/8"	25 5/8"

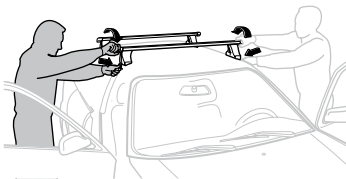
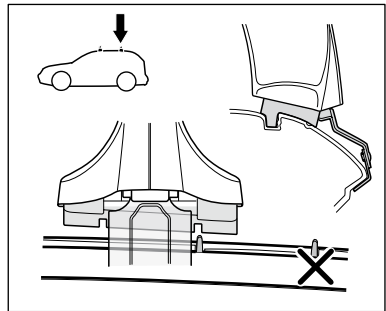
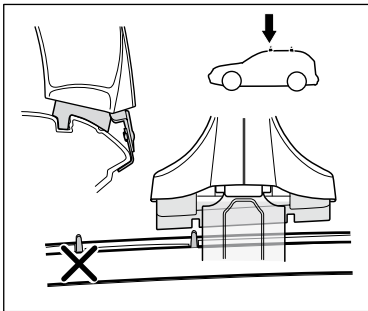
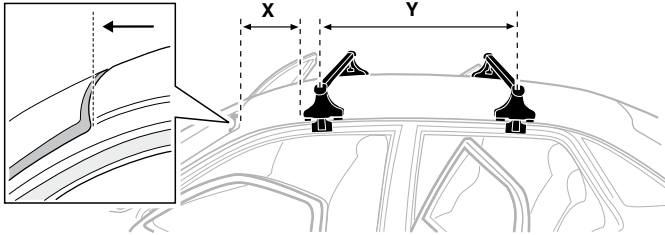

GB/US Tighten alternately

D Die Schrauben abwechselnd anziehen

F Serrer alternativement chaque côté

NL Afwisselend aan de linker- en de rechterkant aandraaien

I Alternare il serraggio delle viti

E Serrare alternativamente

PT Aperte alternadamente

S Dra åt växelvis

FIN Kierrä vuorotellen

EST Pinguldage vaheldumisi

LAT Pievelciēt pamīšus

LIT Užsukinėkite pakaitomis

PL Śruby dokręcaj naprzemiennie

RU Затягивайте попеременно

CZ Pokręťte багаžníka dokręcaj dokręcaj naprzemiennie.

SK Dotiahujte striedavo

SLO Privijajte izmenično.

HR Naizmjenično zategnite

HU Egy mástól függetlenül szorítandó

GR Σφιγγετε εναλλάξ

TR Dönüşümlü sıkın

中文 交替拧紧

한국어 번갈아 가며 조이십시오.

日本語 交互に締め付けてください。

ไทย ชั้้นในแบบสลับ

6

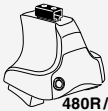

480R/754



480

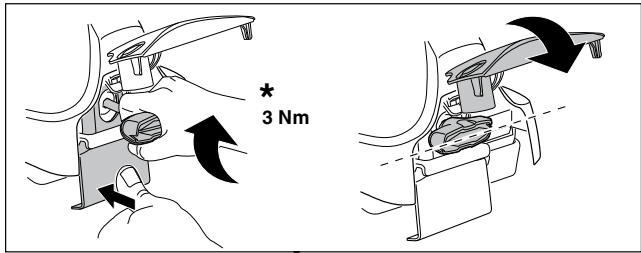
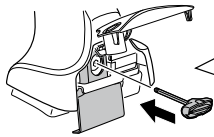

*
3 Nm

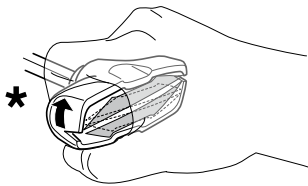

*

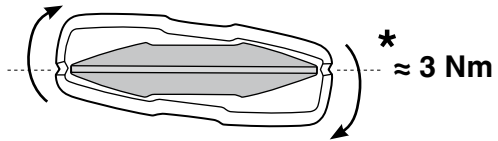

*
≈ 3 Nm

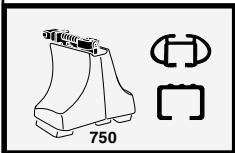
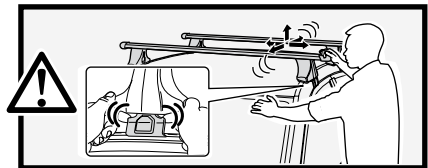

750

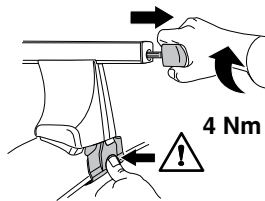

4 Nm

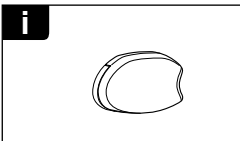
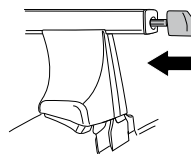

i

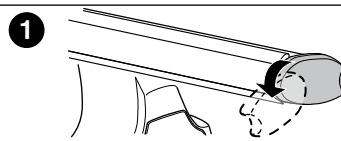

1

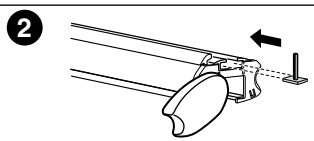

2

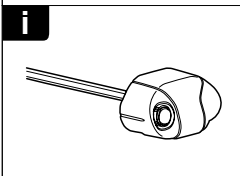

i

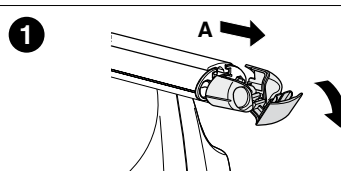

1

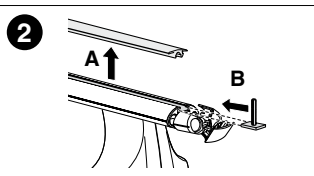

2

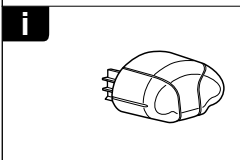

i

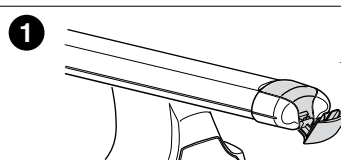

1

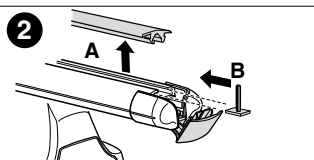

2

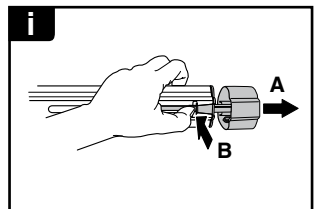
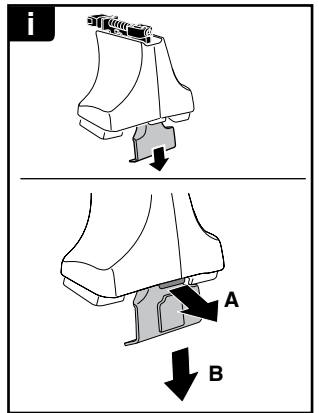
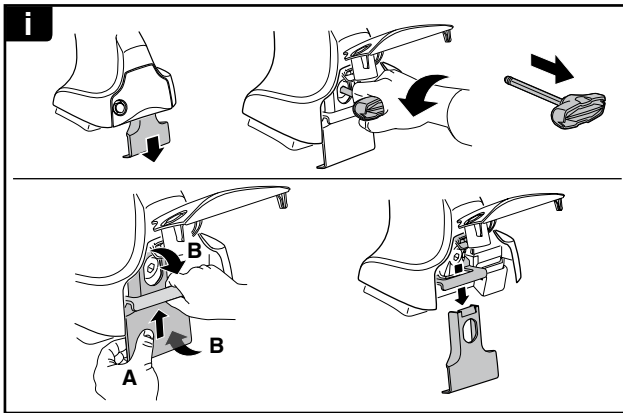
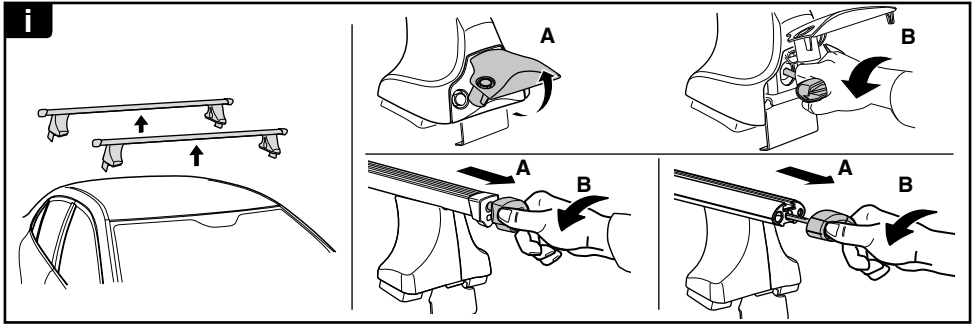

THULE
SWEDEN
**ONE
KEY
SYSTEM**

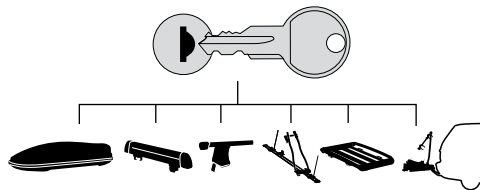

		(x4)
		(x6)
		(x8)
NA		(x10)
EUR		(x12)
ASIA		(x12)

