

Kit 1402

SUZUKI Escudo, 5-dr SUV, 05-*

SUZUKI Grand Vitara, 5-dr SUV, 05-*

* Without railing

480R
754

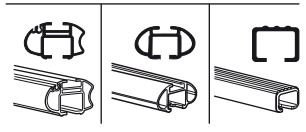
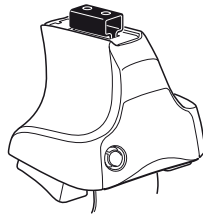

480

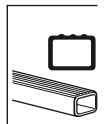
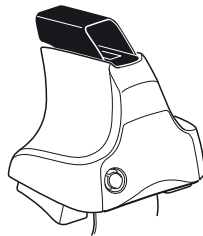

750

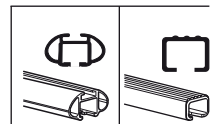
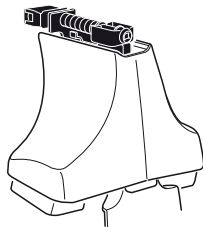

Kit



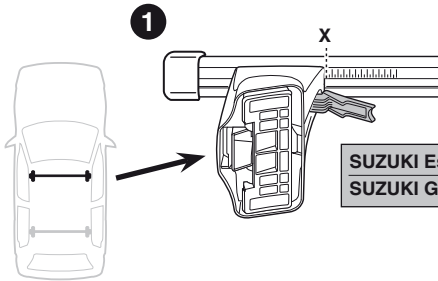

	X
SUZUKI Escudo, 5-dr SUV, 05-	41,5
SUZUKI Grand Vitara, 5-dr SUV, 05-	41,5

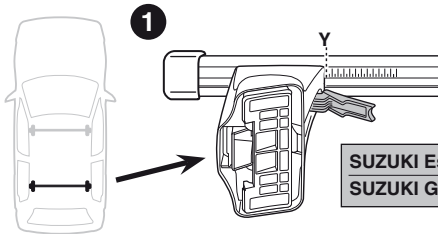

	Y
SUZUKI Escudo, 5-dr SUV, 05-	37,5
SUZUKI Grand Vitara, 5-dr SUV, 05-	37,5

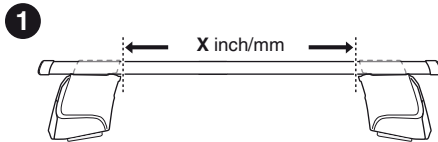
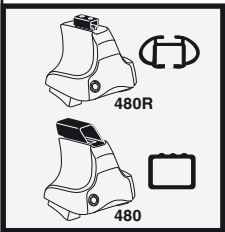

	X inch	X mm
SUZUKI Escudo, 5-dr SUV, 05-	42"	1066 mm
SUZUKI Grand Vitara, 5-dr SUV, 05-	42"	1066 mm

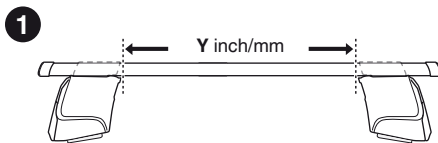
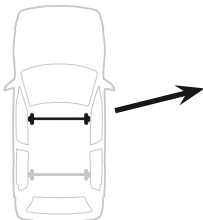

	Y inch	Y mm
SUZUKI Escudo, 5-dr SUV, 05-	40 ³ / ₈ "	1026 mm
SUZUKI Grand Vitara, 5-dr SUV, 05-	40 ³ / ₈ "	1026 mm

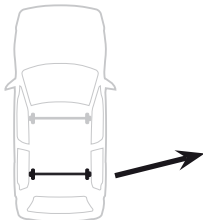

4

SUZUKI Escudo, 5-dr SUV, 05-
 SUZUKI Grand Vitara, 5-dr SUV, 05-

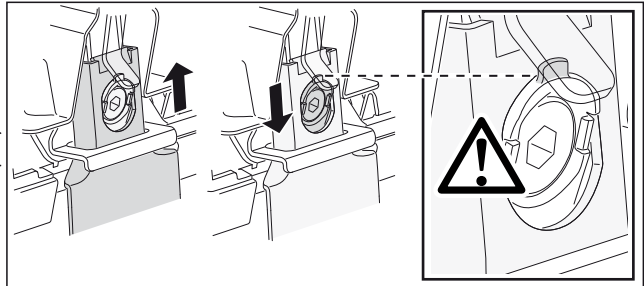
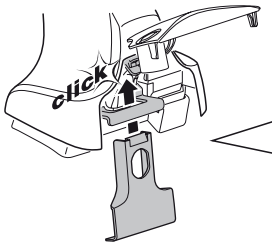
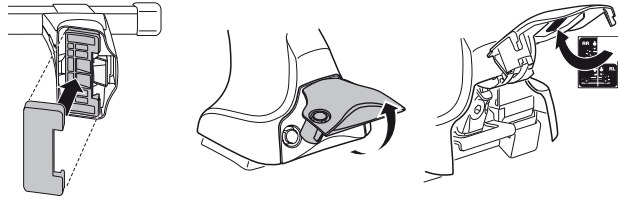
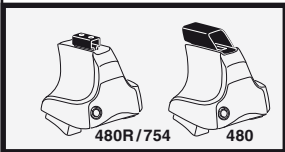
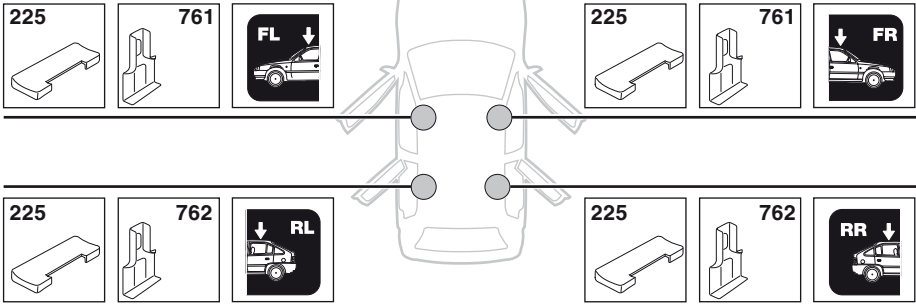

5



	X mm	Y mm	X inch	Y inch
SUZUKI Escudo, 5-dr SUV, 05-	265 mm	715 mm	10 ³ / ₈ "	28 ¹ / ₈ "
SUZUKI Grand Vitara, 5-dr SUV, 05-	265 mm	715 mm	10 ³ / ₈ "	28 ¹ / ₈ "

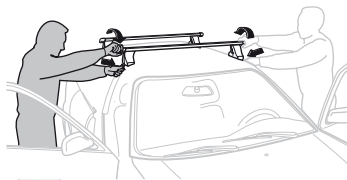
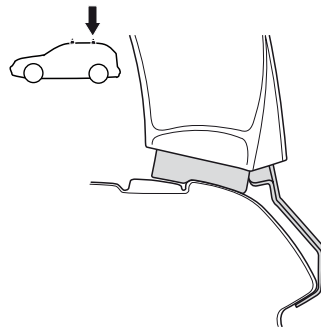
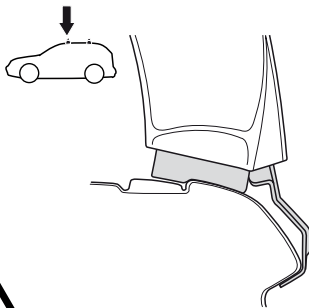
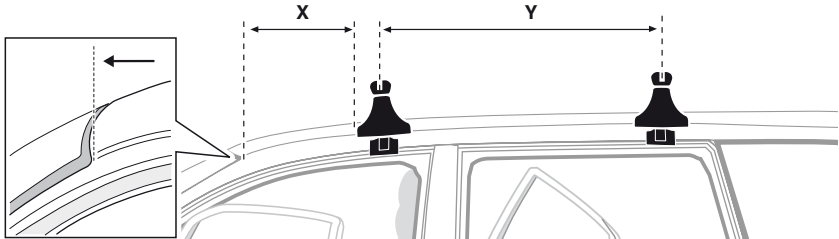

GB/US Tighten alternately

D Die Schrauben abwechselnd anziehen

F Serrer alternativement chaque côté

NL Afwisselend aan de linker- en de rechterkant aandraaien

I Alternare il serraggio delle viti

E Apretar alternativamente

PT Aperte alternadamente

S Dra åt växelvis

FIN Kierrä vuorotellen

EST Pinguldage vaheldumisi

LAT Pielieciet pamišus

LIT Užsukinėkite pakaitomis

PL Śruby dokręcaj naprzemiennie

RU Затягивайте попеременно

CZ Pokręťta багаžníka dokręcaj dokręcaj naprzemiennie.

SK Doťahujte striedavo

SLO Privijajte izmenično.

HR Naizmjenično zategnite

HU Egymástól függetlenül szorítandó

GR Σφίγγετε εναλλάξ

TR Dönüşümlü sıkın

中文 交替拧紧

한국어 번갈아 가며 조이십시오.

日本語 交互に締め付けてください。

ไทย ชั้้นโน้บแบบสลับ

6



480R/754



480

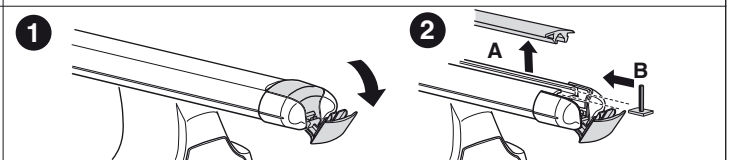
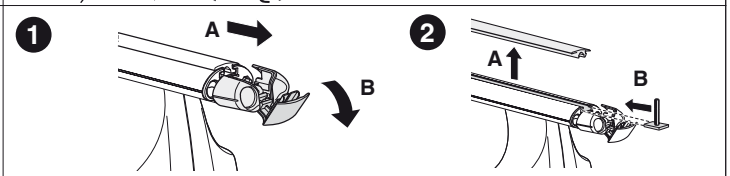
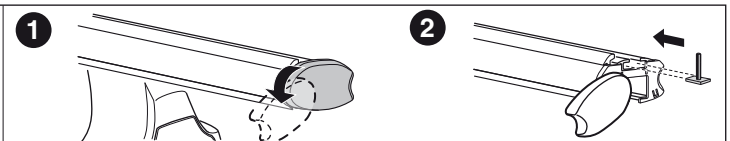
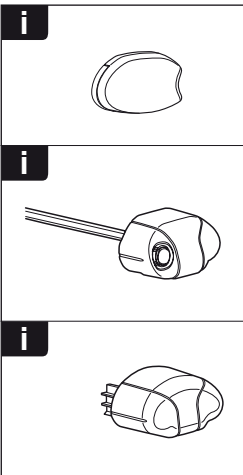
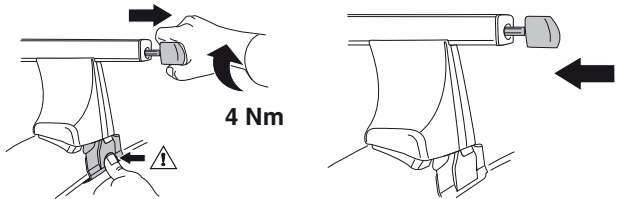
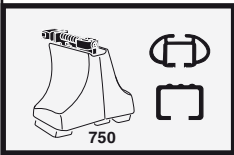
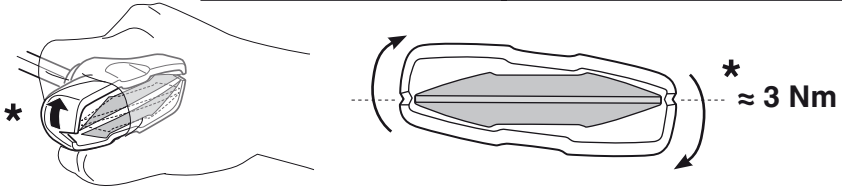
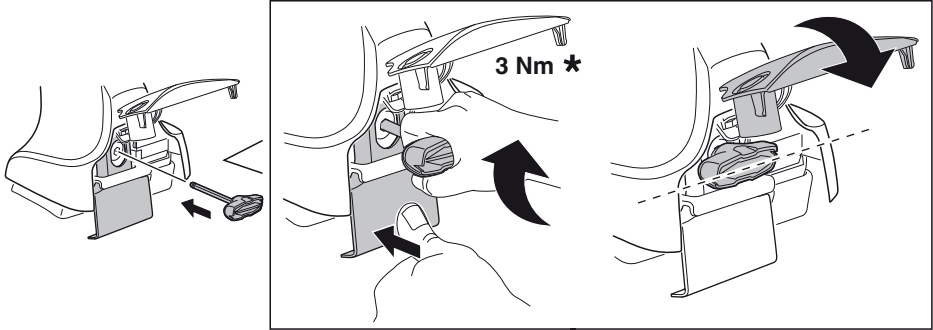



THULE
SWEDEN
**ONE
KEY
SYSTEM**



- 544 (x4)
- 596 (x6)
- 588 (x8)
- NA 510 (x10)
- EUR 452 (x12)
- ASIA



WW ▶ Thule Sweden AB, Box 69, 330 33 Hillerstorp, SWEDEN
NA ▶ Thule Inc., 42 Silvermine Road, Seymour, Connecticut 06483, USA

info@thule.com
customer.service@thule.com

www.thule.com