

Kit 1591

AUDI A6, 4-dr Sedan, 04-

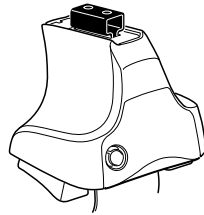

480R
754

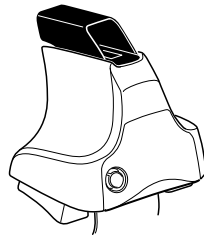
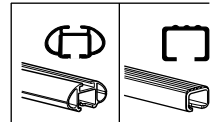

480

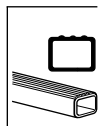

x1

x4

x4

x4

480R/754

x1

x4

x4

x4

480

x2	x2 23 mm	x1 17 mm	x2 23 mm	x2
x2	x2 23 mm	x2 23 mm	x2	x2
x4	x4	x2	x2	x2
x4	x4	x2	x2	x2

x2	x2	x1	x1
x2	x2	x1	x1
x2	x2	x1	x1
x2	x2	x1	x1

x1

Kit

1

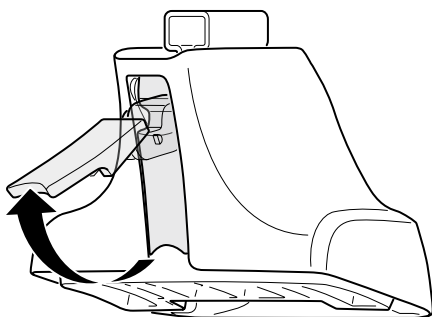
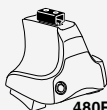

2

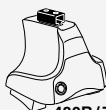

+

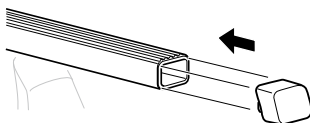
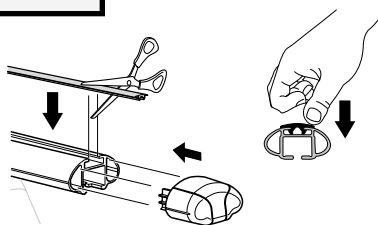
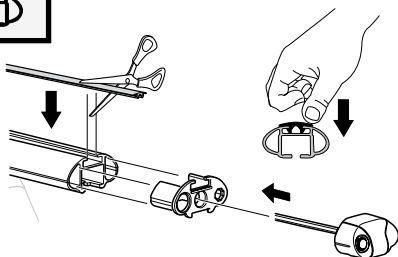
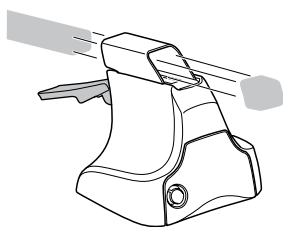
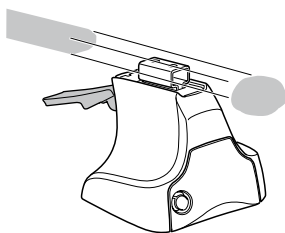

3

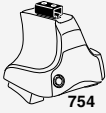

754

1

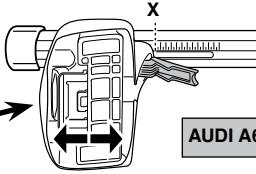
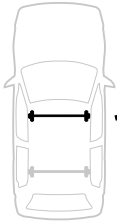

2

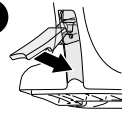

AUDI A6, 4-dr Sedan, 04-

X

36

1

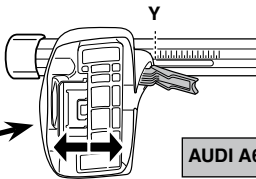
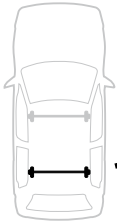

2

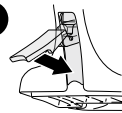

AUDI A6, 4-dr Sedan, 04-

Y

36

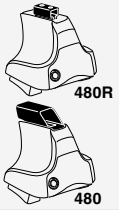

480R

480

1

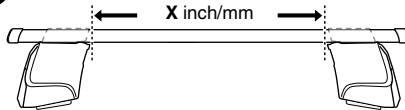

2

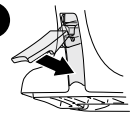

AUDI A6, 4-dr Sedan, 04-

X inch

X mm

39 3/4"

1011 mm

1

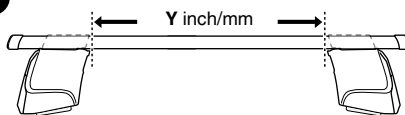

2

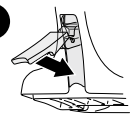

AUDI A6, 4-dr Sedan, 04-

Y inch

Y mm

39 3/4"

1011 mm

4



480R/754



480

AUDI A6, 4-dr Sedan, 04-

260



1090



259



1090



29



911



30



911

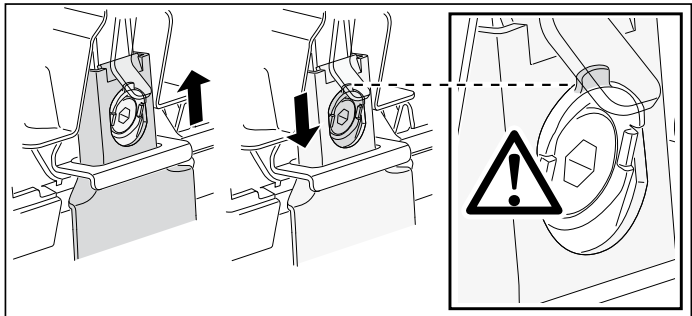
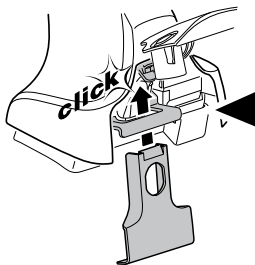
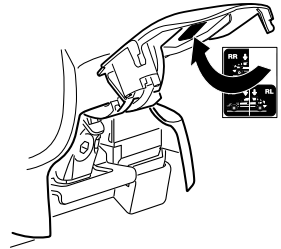
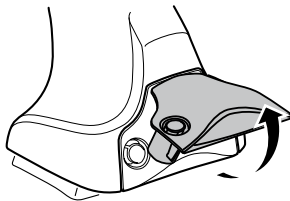
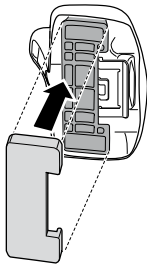

5



	X mm	Y mm	X inch	Y inch
AUDI A6, 4-dr Sedan, 04-	215 mm	790 mm	8 1/2"	31 1/8"

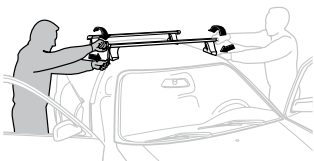
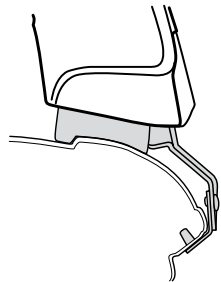
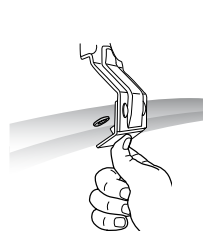
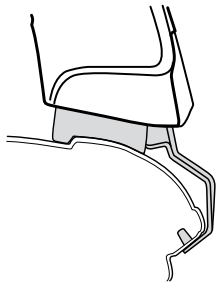
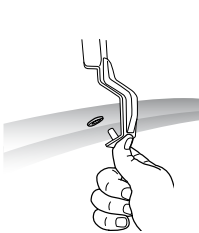
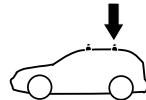
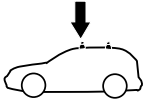
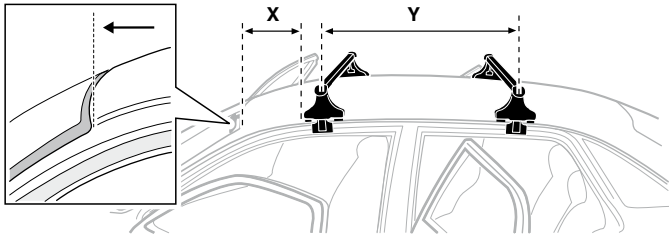

GB/US Tighten alternately

D Die Schrauben abwechselnd anziehen

F Serrer alternativement chaque côté

NL Afwisselend aan de linker- en de rechterkant aandraaien

I Alternare il serraggio delle viti

E Apretar alternativamente

PT Aperte alternadamente

S Dra åt växelvis

FIN Kierrä vuorotellen

EST Pinguldage vaheldumisi

LAT Pievelciēt pamīšus

LIT Užsukinėkite pakaitomis

PL Śruby dokręcaj naprzemiennie

RU Затягивайте попеременно

CZ Pokrétla bagazníka dokręcaj dokręcaj naprzemiennie.

SK Dotahujte striedavo

SLO Privijajte izmenično.

HR Naizmjenično zategnite

HU Egy mástól függetlenül szorítandó

GR Σφιγγετε εναλλάξ

TR Dönüşümlü sıkın

中文 交替拧紧

한국어 번갈아 가며 조이십시오.

日本語 交互に締め付けてください。

ไทย ขึ้นในแบบสลับ

ไทย ขึ้นในแบบสลับ

ไทย ขึ้นในแบบสลับ

ไทย ขึ้นในแบบสลับ

ไทย ขึ้นในแบบสลับ

ไทย ขึ้นในแบบสลับ

ไทย ขึ้นในแบบสลับ

ไทย ขึ้นในแบบสลับ

ไทย ขึ้นในแบบสลับ

ไทย ขึ้นในแบบสลับ

ไทย ขึ้นในแบบสลับ

6



480R/754



480

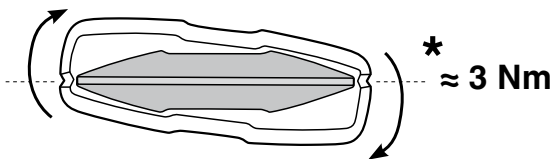
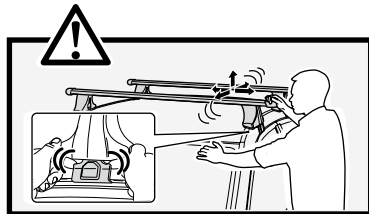
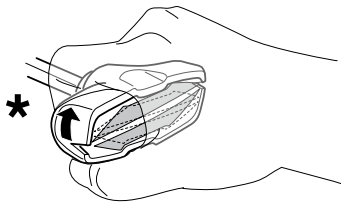
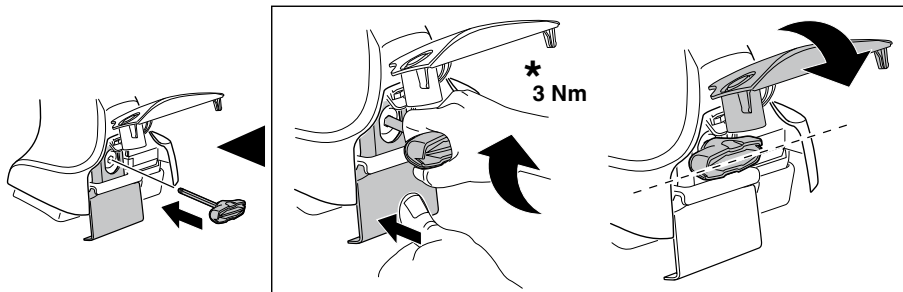

7

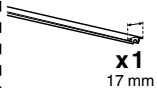

x1
17 mm

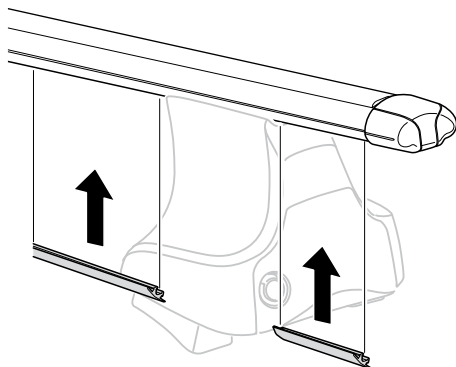

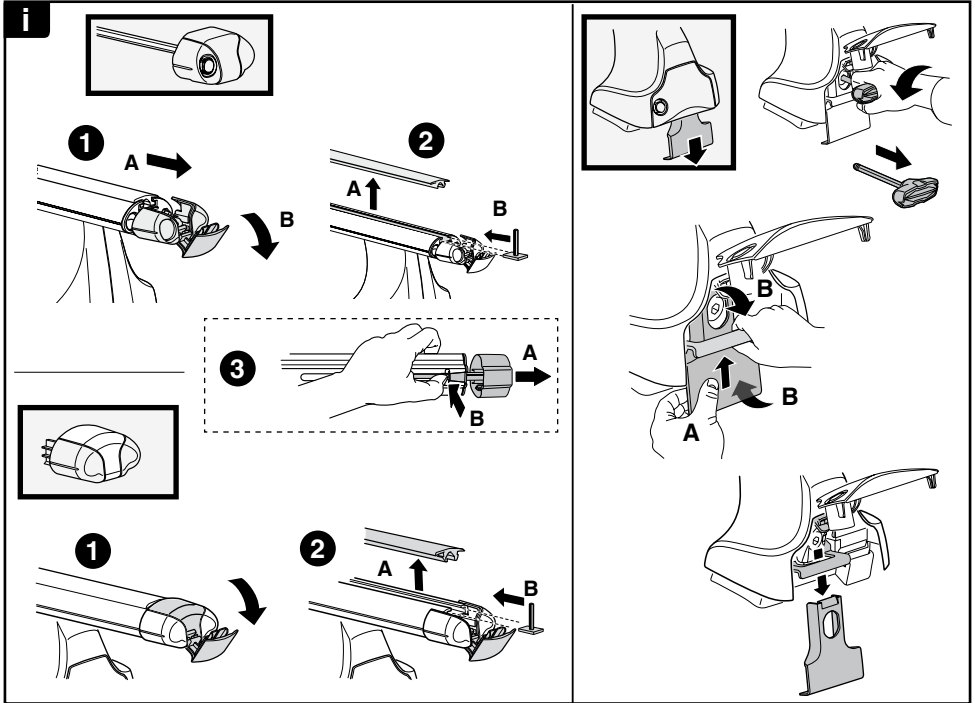

THULE
SWEDEN
**ONE
KEY
SYSTEM**

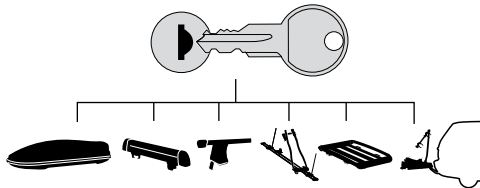

- 544** (x4)
- 596** (x6)
- 588** (x8)
- NA **510** (x10)
- EUR **452** (x12)
- ASIA

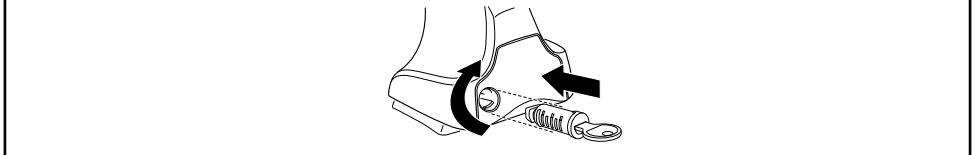

WW ▶ Thule Sweden AB, Box 69, 330 33 Hillerstorp, SWEDEN
NA ▶ Thule Inc., 42 Silvermine Road, Seymour, Connecticut 06483, USA

info@thule.com
customer.service@thule.com

www.thule.com