

# Kit 3110

FIAT Punto, 5-dr Hatchback, 99-02, 03-

This Kit is only for vehicles with fixpoint mounting.

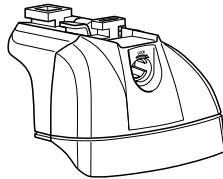

460R  
753

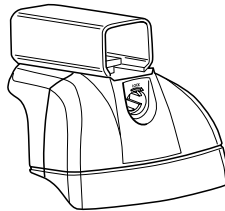



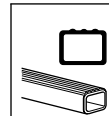



460





 $xx \text{ kg} + 5 \text{ kg} =$   
 $xx \text{ lbs} + 11 \text{ lbs} =$

**Max. 40kg**  
**Max. 88 lbs**



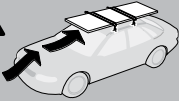

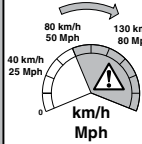
**Kit XXXX**





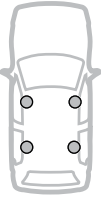









**80 km/h**  
**50 Mph**  
**130 km/h**  
**80 Mph**  
**40 km/h**  
**25 Mph**  
**km/h**  
**Mph**



**A**

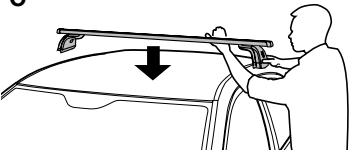

**B**

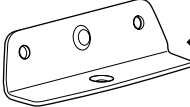

**C**

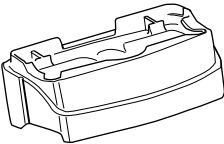





**01 x 4**



**151 x 4**



**x 4**



**x 1**

**50784**

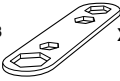
**x 4**

**50786**

**x 4**

**51326**

**x 4**

**50273**

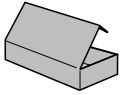
**x 1**

**51294**

**x 1**  
**3 mm**

**Kit**

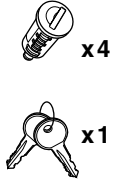
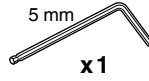
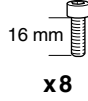
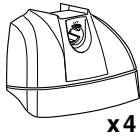
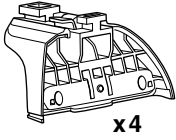

753



460R

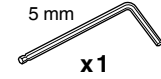
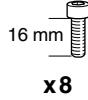
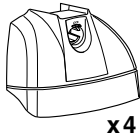
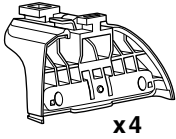

460

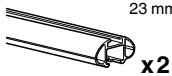
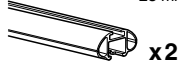
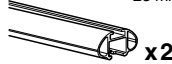
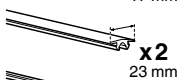
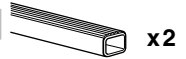
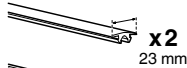
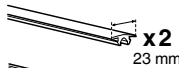
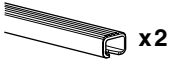
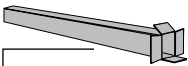
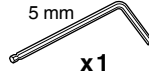
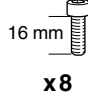
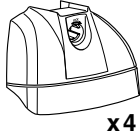
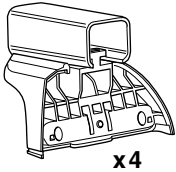

1

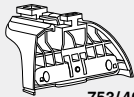

753/460R

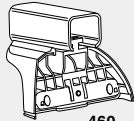

460

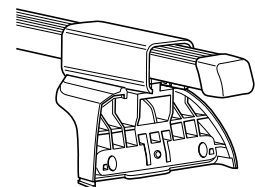
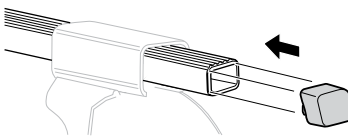
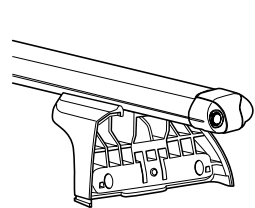
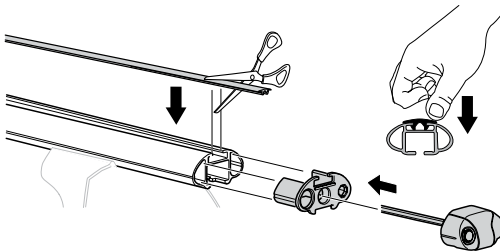
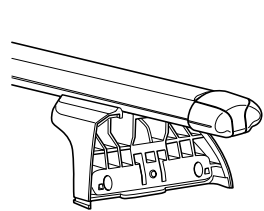
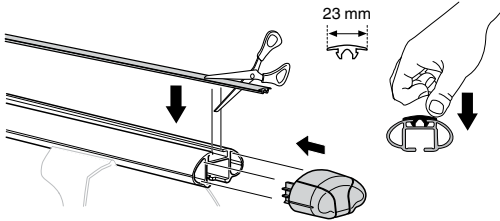
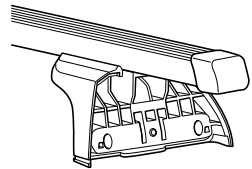
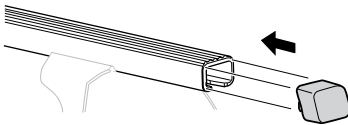
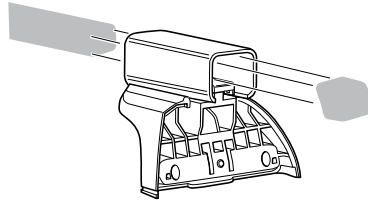
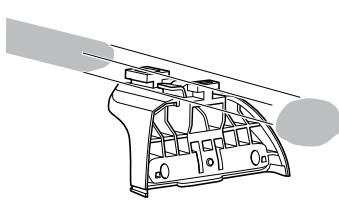

2

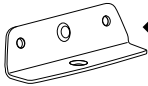

◀ 01 x 4



◀ 151 x 4

16 mm  x 8



x 1

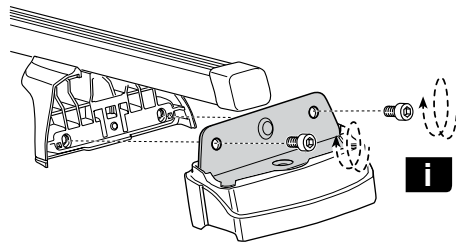
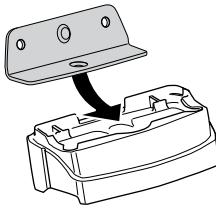
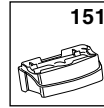
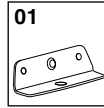
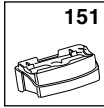
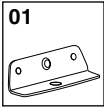
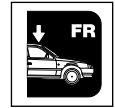
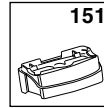
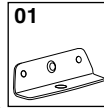
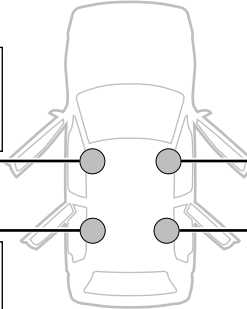
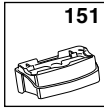
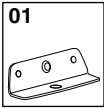

**i**

**GB** Only a few turns  
**D** Nur wenige Umdrehungen  
**F** Quelques tours uniquement  
**NL** Slechts enkele slagen  
**I** Solo qualche giro  
**E** Sólo algunas vueltas  
**PT** Noções básicas  
**S** Endast några varv  
**FIN** Vain muutama kierros

**EST** Ainult mõni pööre  
**LAT** Tikai dažī apgriezieni  
**LIT** Tik keli pasukimai  
**PL** Wystarczy kilka obrotów  
**RU** Достаточно нескольких оборотов  
**CZ** Pouze několik otáček  
**SK** Len niekoľko otáčok  
**SLO** Le nekaj obratov

**HR** Samo nekoliko okreta  
**HU** Csak néhány fordítás  
**GR** Μόνο μερικές στροφές  
**TR** Yalnız birkaç kez çevirm  
**中文** 只有几个转向  
**한국어** 두 세번만  
**日本語** 数回転のみ  
**ไทย** หมุนเพียงไม่กี่รอบ

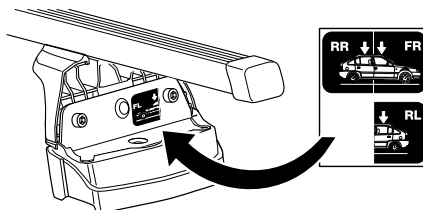

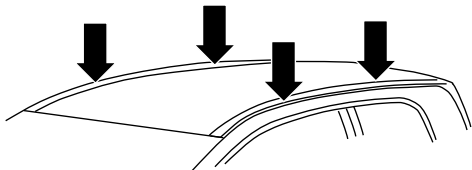
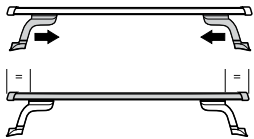
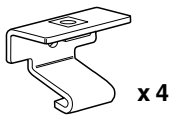
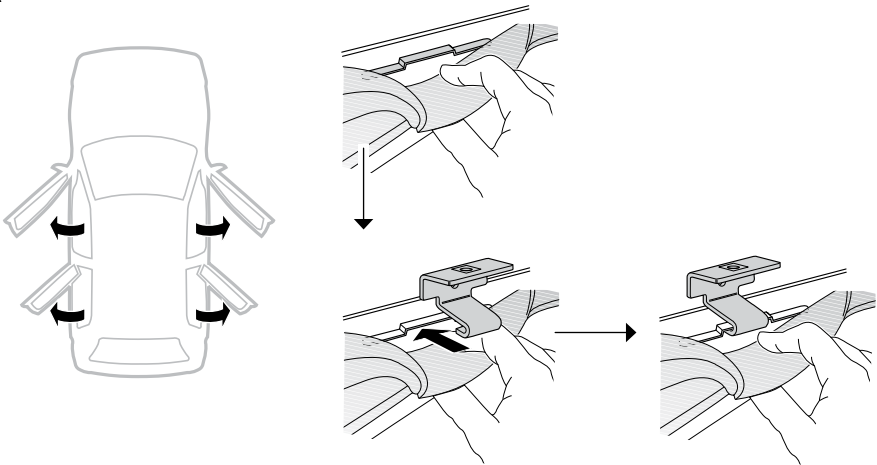
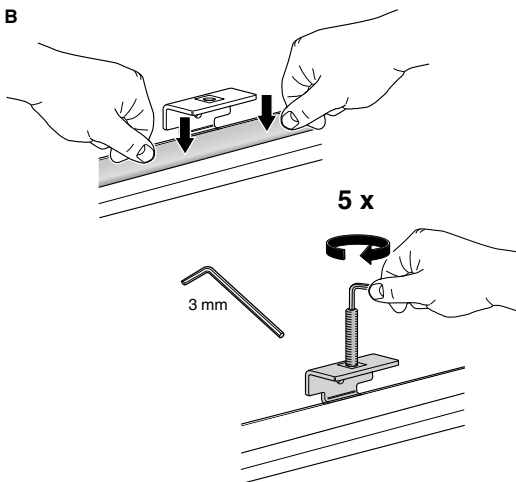
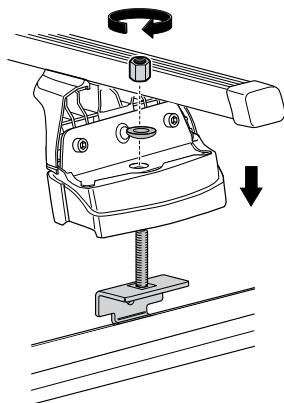
**3****A****B****C**

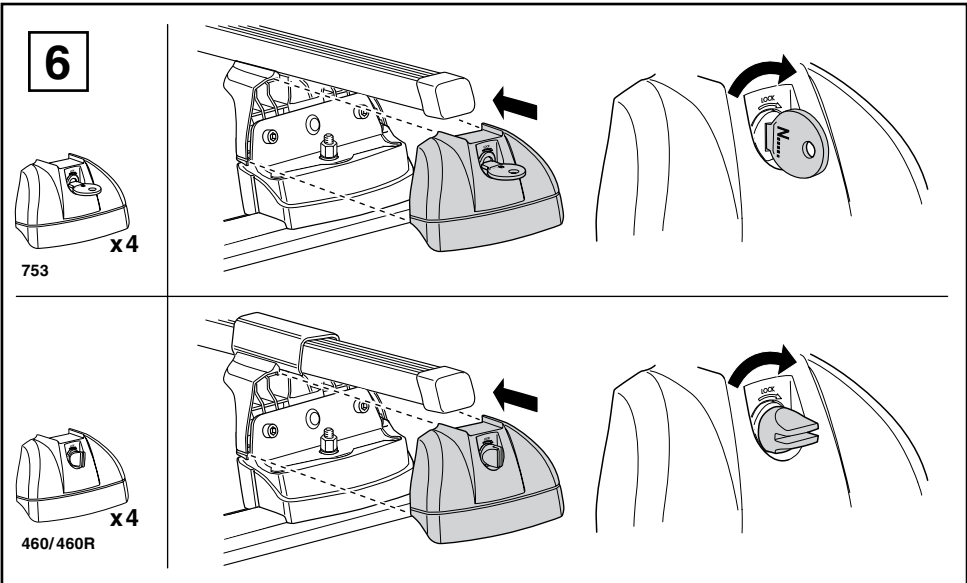
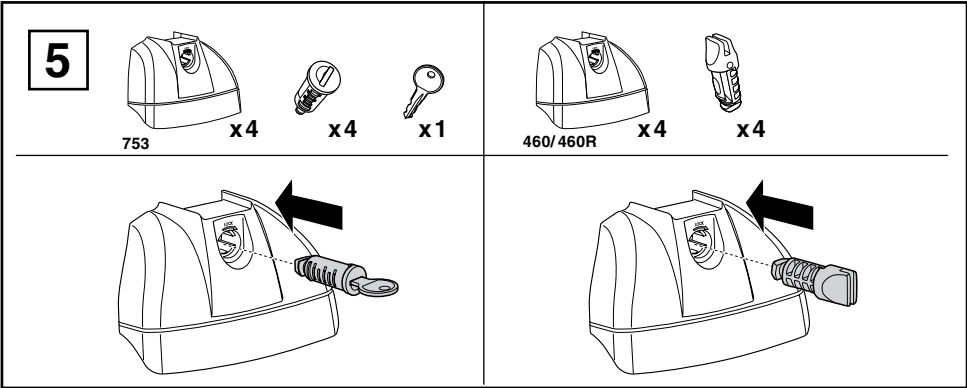
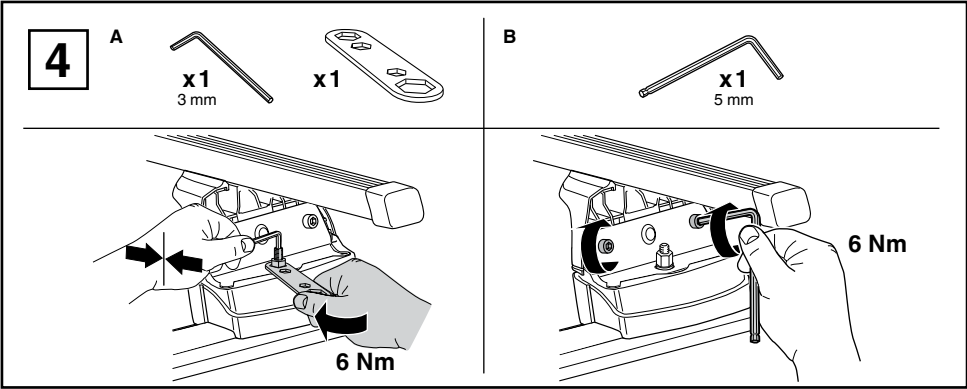

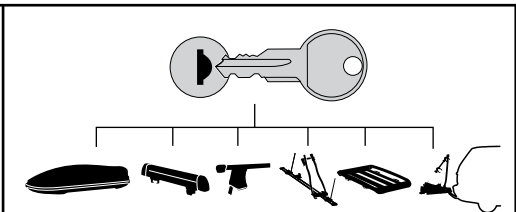
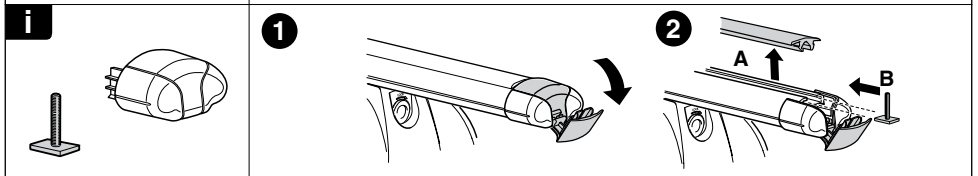
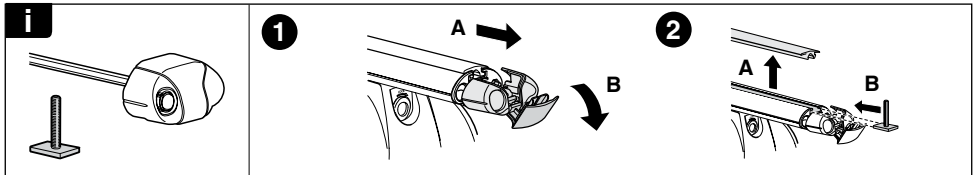
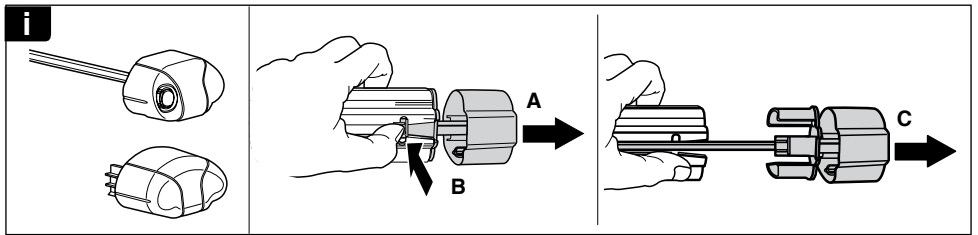
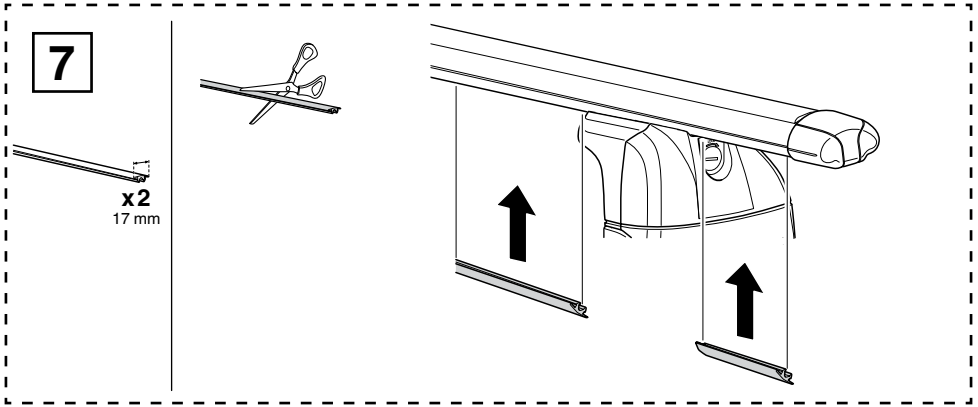

- 544 (x4)
- 596 (x6)
- 588 (x8)
- NA 510 (x10)
- EUR ASIA 452 (x12)

**WW** ▶ Thule Sweden AB, Box 69, 330 33 Hillerstorp, SWEDEN  
**NA** ▶ Thule Inc., 42 Silvermine Road, Seymour, Connecticut 06483, USA

info@thule.com  
 customer.service@thule.com

www.thule.com