

Fit tips!

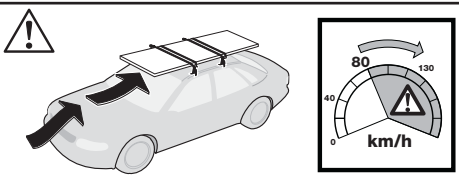

838

GB Accessories	SK Príslušenstvo
D Zubehör	SLO Dodatki
F Accessoires	HR Dodaci
NL Accessoires	HU Tartozékok
I Accessori	GR Παρελκόμενα
E Accesorios	TR Aksesuarlar
PT Acessórios	中文 附件
S Tillbehör	日本語 付属品
FIN Lisävarusteet	한국어 액세서리
EST Lisavarustus	ไทย อุปกรณ์เสริม
LAT Piederumi	
LIT Priedai	
PL Akcesoria	
RU Аксессуары	
CZ Doplnky	

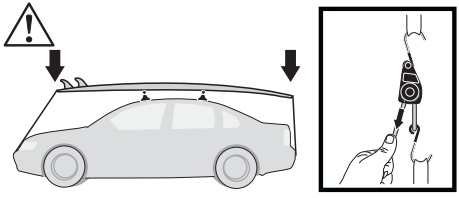
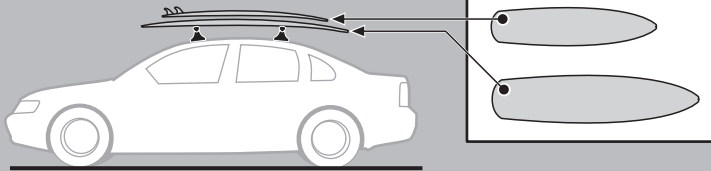
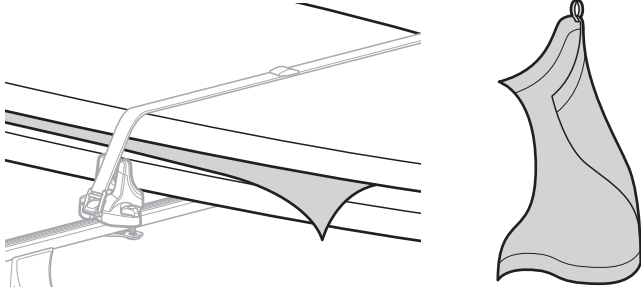
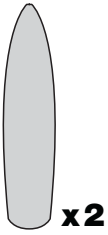

THULE[®]
SWEDEN

- GB** Fitting instructions
- D** Montageanleitung
- F** Instructions de montage
- NL** Montage-instructies
- I** Istruzioni per il montaggio
- E** Instrucciones de montaje
- PT** Instruções de Montagem
- S** Monteringsanvisning
- FIN** Asennusohje
- EST** Paigaldusjuhend
- LAT** Stiprināšanas instrukcija
- LIT** Pritvirtinimo instrukcijos
- PL** Instrukcja montażu
- RU** Инструкции по установке
- CZ** Návod na montáž

- SK** Návod na montáž
- SLO** Navodila za pritrjevanje
- HR** Uputa za sastavljanje
- HU** A felszerelés módja
- GR** Οδηγίες συναρμολόγησης
- TR** Montaj talimatları
- 中文** 安装说明
- 日本語** 取扱(取付)説明書
- 한국어** 장착 지침
- ไทย** คำแนะนำการติดตั้ง

832
832000



Follow me...

THULE[®]
SWEDEN

Box 69, 330 33 Hillerstorp, SWEDEN
www.thule.com

20100520•4DF/501-7008-05

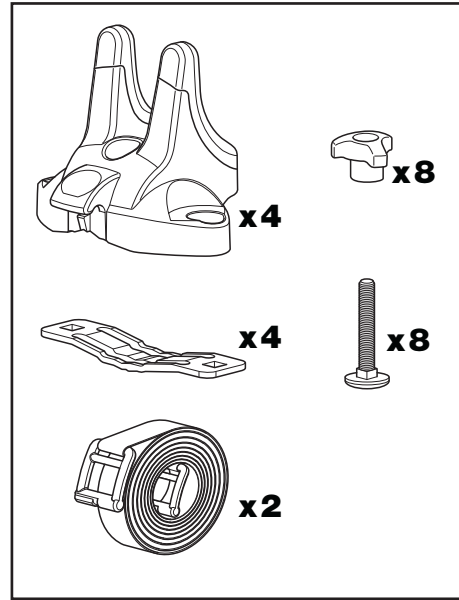
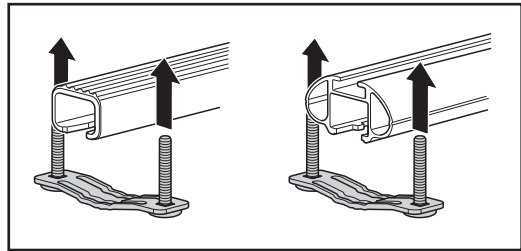
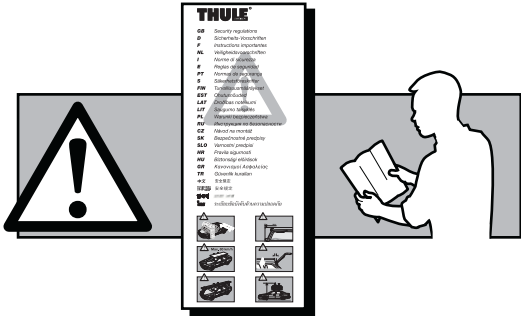

1

* GB Only a few turns
 * D Nur wenige Umdrehungen
 * F Quelques tours uniquement
 * NL Slechts enkele slagen
 * I Solo qualche giro
 * E Sólo algunas vueltas
 * PT Noções básicas
 * S Endast några varv
 * FIN Vain muutama kierros
 * EST Ainult mõni pööre
 * LAT Tikai daži apgrīzieni
 * LIT Tik keli pasukimai
 * PL Wystarczy kilka obrotów
 * RU Достаточно нескольких оборотов
 * CZ Pouze několik otáček
 * SK Len niekoľko otáčok
 * SLO Le nekaj obratov
 * HR Samo nekoliko okreta
 * HU Csak néhány fordítás
 * GR Μόνο μερικές στροφές
 * TR Yalnız birkaç kez çevirme
 * 中文 只有几个转向
 * 한국어 두 세번만
 * 日本語 数回転のみ
 * ไทย หมุนเพียงไม่กี่รอบ

2

Min 610 mm

3 Nm

3