

# 1

## Kit 5220

LEXUS ES-Series, 4-dr Sedan, 19-

ISO 11154-E

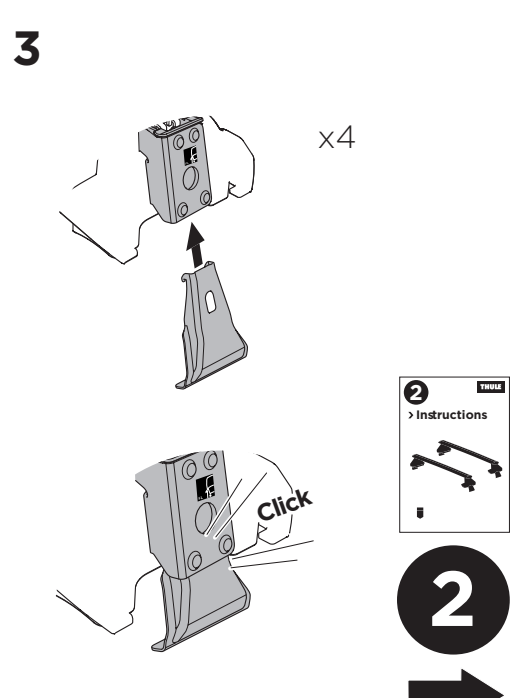
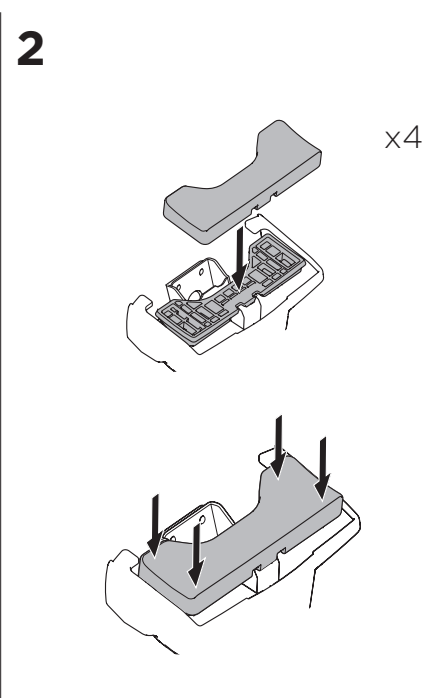
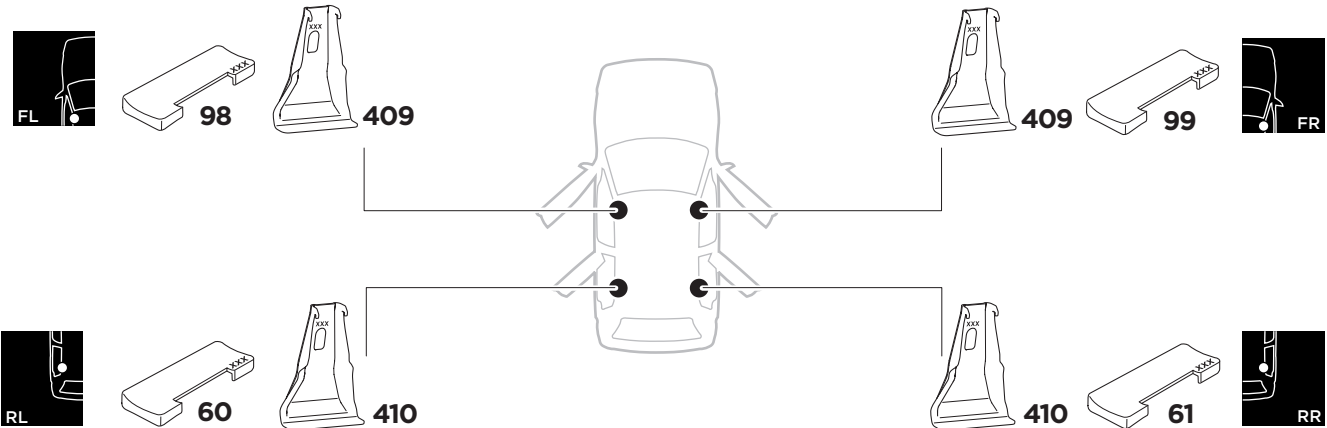
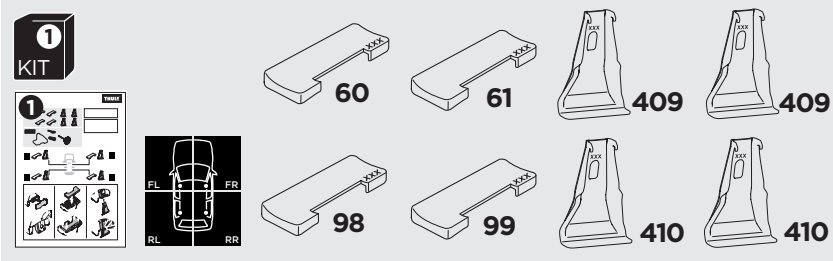



THULE WingBar Evo	THULE WingBar Edge	THULE WingBar	THULE SquareBar	<b>Evo X (scale)</b>	<b>Edge X (scale)</b>
<b>LEXUS ES-Series, 4-dr Sedan, 19-</b>				<b>41,5</b>	<b>N</b>

THULE ProBar	THULE SlideBar	<b>X (mm/inch)</b>		
<b>LEXUS ES-Series, 4-dr Sedan, 19-</b>		<b>1066 mm / 42"</b>		



THULE WingBar Evo	THULE WingBar Edge	THULE WingBar	THULE SquareBar	<b>Evo Y (scale)</b>	<b>Edge Y (scale)</b>
<b>LEXUS ES-Series, 4-dr Sedan, 19-</b>				<b>36</b>	<b>G</b>

THULE ProBar	THULE SlideBar	<b>Y (mm/inch)</b>		
<b>LEXUS ES-Series, 4-dr Sedan, 19-</b>		<b>1011 mm / 39 3/4"</b>		

	<b>W (mm/inch)</b>	<b>Z (mm/inch)</b>
<b>LEXUS ES-Series, 4-dr Sedan, 19-</b>	<b>690 mm / 27 1/8"</b>	<b>200 mm / 7 7/8"</b>

