

2020mm Length

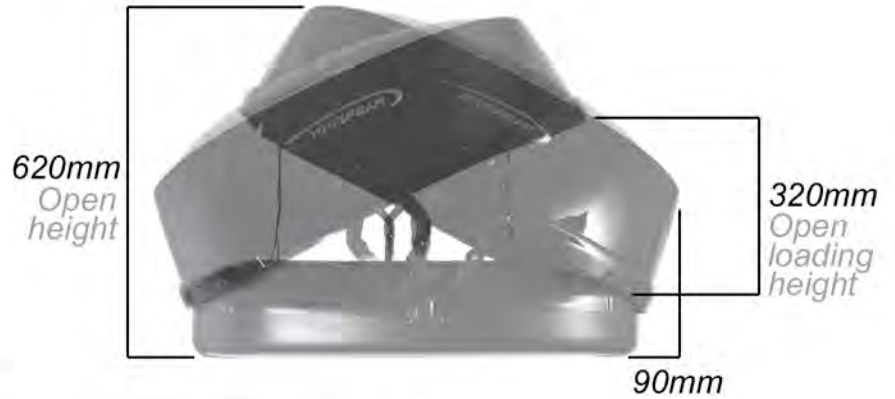

Colour - Silver
Finish - Gloss
Capacity - 450 litres
Opens from - Dual side opening
Opening struts - Dual struts
Locking system - Rotary
T-track - Yes
Weight - 19kg
Max load capacity - 75kg
Fits bars up to- all T-track alu bars
Max no of skis - 4-6 or 2 snowboards
Internal Width - 820mm
Internal length - 1960mm
Length of guarantee - 5 yrs

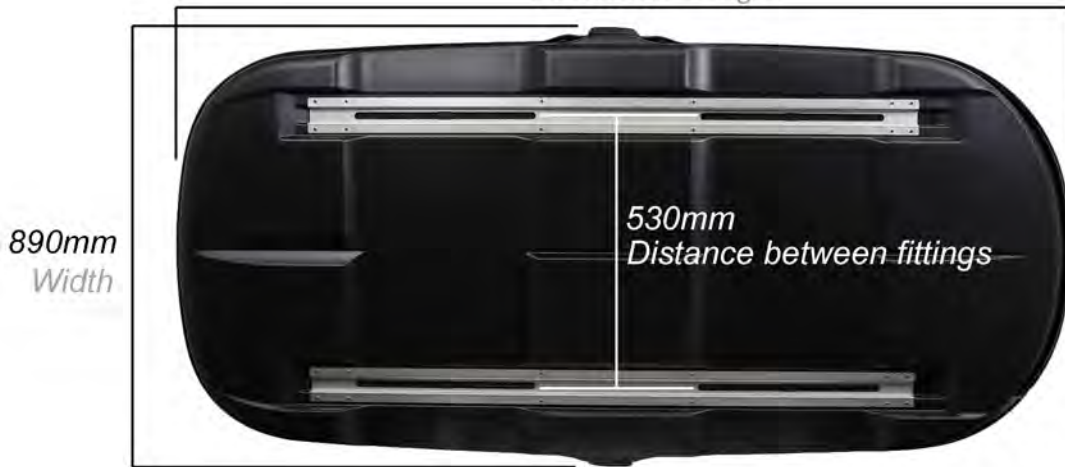